

ATX™ FDLED Series Luminaires

Standard or with Emergency Battery Backup
Flameproof

ATEX/IECEx: Zone 1 and 2, 21 and 22 | Ⓜ II 2 GD | IP66/68 | IK08 or IK09

Applications

- Can be installed in hazardous areas designated as Zone 1 and 2 – 21 and 22.
- For use in locations where a high degree of corrosion resistance is required.
- For indoor/outdoor use where protection against dirt, water and moisture is necessary.
- Typical applications include:
 - Oil refineries
 - Petrochemical facilities
 - Pulp and paper, mills
 - Painting, sewage and water treatment facilities
 - Warehouses
 - Underground tunnels
 - General manufacturing facilities
 - Hydrogen and Biofuels plants
 - LNG (Liquid Natural Gas) plants

Features

- Impact resistant borosilicate glass sealed tube.
- Easy access to LED array through gray painted aluminum threaded entry cap.
- Supplied with O-ring for improved ingress protection.
- Corrosion-resistant gray painted aluminum.
- Supplied with energy efficient electronic driver on a removable gear tray.
- Supplied with external and internal ground/earth connection.
- Fixture supplied with one M20 blanking plug.
- Easy connection to wire and disconnect with plug-in terminal blocks.
- 5 year standard warranty.

Standard Materials

- End caps and cover: aluminum.
- Glass tube: tempered borosilicate glass.
- O-ring gasket: nitrile (NBR).
- Internal reflector: aluminium.
- Mounting accessories: several accessories in different material such as zinc plated steel, galvanized steel or 316 stainless steel.

Options

- Diffused polycarbonate lens
- Ta -50 °C (-58 °F) IP66 (without gasket)
- Ta -40 °C (-40 °F) IP66/68 (with gasket)

ATEX/IECEx Certifications and Compliances

- Certification Type FDLED
 - Gas: Zone 1 and 2:
 - Conforming to ATEX 2014/34/UE: Ⓜ II 2 G
 - Type of Protection: Ex db IIC Gb
 - Temperature Class: T6
 - Dust: Zone 21 and 22:
 - Conforming to ATEX 2014/34/UE: Ⓜ II 2 D
 - Type of Protection: Ex tb IIC Db
 - Surface Temperature: +80 °C (+176 °F)



4725 lm (IIB)



2400 lm (IIB+H2)

- Ambient Temperature:
 - Standard Version: -50 °C to +60 °C (-58 °F to +140 °F)
 - Emergency Version: -20 °C to +60 °C (-4 °F to +140 °F)
- CE Declaration of Conformity: 50312
- ATEX Certificate: INERIS 15 ATEX 0042X
- IECEx Certificate: IECEx INE 15.0046X
- UKEX Certificate: CML 21UKEX1156X
- Index of Protection according EN/IEC 60529: IP66/68
- Impact Resistance (shock): IK09 (2400 lm version), IK08 (4725 lm version)
- Internal Volume: > 2 dm³ (122 in³) - 2 liters

Other Certifications

- INMETRO Certificate: BVC17.5710-X

ATX™ FDLED Series Luminaires

Standard or with Emergency Battery Backup
Flameproof

ATEX/IECEX: Zone 1 and 2, 21 and 22 | II 2 GD | IP66/68 | IK08 or IK09

Order Using Catalog Numbering Guide — FDLED Series Luminaires

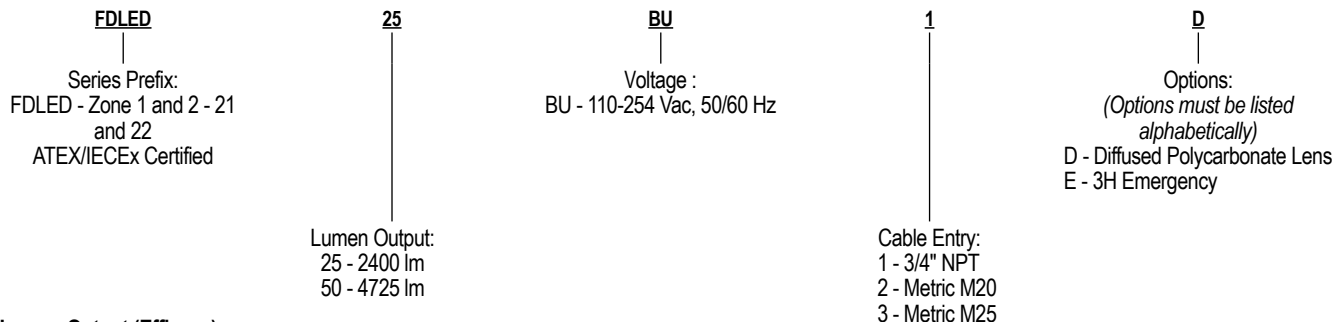

Lumen Output (Efficacy)

Model	Fluorescent Equivalency	Light Distribution Pattern	CCT (Correlated Color Temperature)	CRI (Color Rendering Index)	Lumen Output	Efficacy (lm/W)
Standard Model — Clear Lens						
FDLED25BU*	2X18W, 3X18W, 1X36W	Linear	5650K	70	2300	104
Emergency Model — Diffused Polycarbonate Lens						
FDLED50BU*	2X36W, 1X58W	Linear	5650K	70	4700	102

Electrical Specifications ②

Model	Voltage	Input Power (Watts)	Input Current (Amps)	Power Factor (PF)	Total Harmonic Distortion (THD)
Standard Model					
FDLED25BU*	110 to 254	23	0.21 @110V	>0.9	<20%
FDLED50BU*	110 to 254	46	0.42 @110V	>0.9	<20%
Emergency Model					
FDLED25BU*E	110 to 254	23	0.21 @110V	>0.9	<20%
FDLED50BU*E	110 to 254	46	0.42 @110V	>0.9	<20%

Temperature Codes

Model Type	Gas IIC — T Rating			Dust — Surface T°		
	Ta = +40 °C (+104 °F)	Ta = +50 °C (+122 °F)	Ta = +55 °C (+131 °F)	Ta = +40 °C (+104 °F)	Ta = +50 °C (+122 °F)	Ta = +55 °C (+131 °F)
Standard Models						
FDLED	T6	T6	T6	+80 °C (+176 °F)	+80 °C (+176 °F)	+80 °C (+176 °F)
FDLED*D	T6	T6	T6	+85 °C (+185 °F)	+85 °C (+185 °F)	+85 °C (+185 °F)
Emergency Models						
FDLED	T6	T6	T6	+80 °C (+176 °F)	+80 °C (+176 °F)	+80 °C (+176 °F)
FDLED*D	T6	T6	T6	+85 °C (+185 °F)	+85 °C (+185 °F)	+85 °C (+185 °F)

“T” Numbers Represent the Maximum Temperature

“T” #	T1	T2	T3	T4	T5	T6
Temp. Range °C (°F)	+301 to +450 (+547 to +842)	+201 to +300 (+394 to +572)	+136 to +200 (+277 to +392)	+101 to +135 (+214 to +275)	+86 to +100 (+187 to +212)	+85 (+185)

① All lumen values are typical (tolerance +/- 10%).

② All values are typical (tolerance +/- 10%). Same electrical ratings apply to each luminaire with different LED position, mounting versions and cable entries.

ATX™ FDLED Series Luminaires

Standard or with Emergency Battery Backup
Flameproof

ATEX/IECEx: Zone 1 and 2, 21 and 22 | Ⓢ II 2 GD | IP66/68 | IK08 or IK09

Wiring Diagram

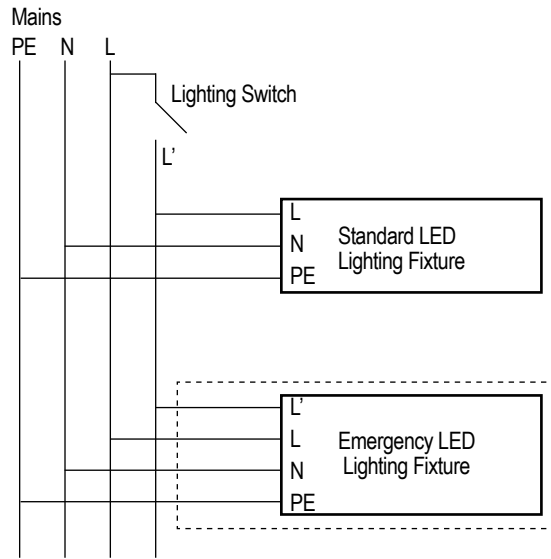

Emergency Function Diagram

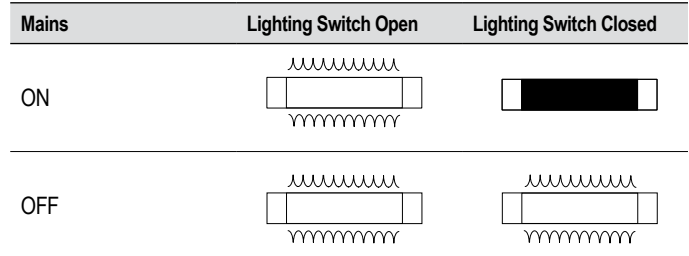

LED Indicator Signals

Color	Timing	Function
Green	LED Blinking	Mains voltage available - Battery Charging
	LED Continuous	Mains voltage available - Battery connected and loaded
Green and Red	LED Blinking Alternately (2s)	Mains voltage available - Battery in repair mode
Red	LED Blinking	Mains voltage available - No battery connected or defective
	LED Continuous	Mains voltage NOT available - Light unit powered by batteries (emergency mode)
	LED Flashing	Mains voltage NOT available - Battery low (emergency mode completed)
Yellow (Orange) and another color	LED Blinking Alternately	Mains voltage available - Last automatic or manual operational check has been unsuccessful
None (Off)	No Light Emitted	Mains voltage NOT available - Battery completely empty

Self-Test: In 3 month intervals batteries are automatically discharged and recharged once.

Emergency Light Duration



Version	Battery Capacity	Duration	Light Output
2400 lm	4 Ah – 6 V	180 minutes	757 lm
4725 lm	7 Ah – 6 V		1417 lm

ATX™ FDLED Series Luminaires

Standard or with Emergency Battery Backup
Flameproof

ATEX/IECEx: Zone 1 and 2, 21 and 22 | II 2 GD | IP66/68 | IK08 or IK09

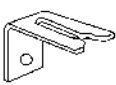
Accessories and Replacement Parts

Description	Weight in kg (lb)	Catalog Number
Protective Guard — Zinc Plated Steel		
 Model 0.4 (for 2400 lm)	0.42 (0.92)	FDPG5Z
Model 0.6 (for 4725 lm)	0.69 (1.52)	FDPG2Z
Fixing Brackets for Ease of Surface Installation — Set of Two		
 Zinc plated steel	0.2 (0.44)	FDFBZ
316 stainless steel	0.27(0.60)	FDFBS
Surface Mounting Brackets — Set of Two		
 Zinc plated steel	0.54 (1.20)	FDSBZ
316 stainless steel	0.45 (1.00)	FDSBS
Half Clamp Brackets for Pole Mounting — Set of Two		
Diameter for 1-1/4" to 1-1/2" pole: 42 mm to 49 mm (1.65" to 1.93")		
• Zinc plated steel	0.34 (0.7)	FDHC49Z
• 316 stainless steel	0.34 (0.7)	FDHC49S
Diameter for 2" pole: 60 mm (2.3")		
• Zinc plated steel	0.48 (1.1)	FDHC60Z
• 316 stainless steel	0.52 (1.2)	FDHC60S
Fall Prevention Kit		
1.20 meter (3.93 feet) stainless steel chain	0.15 (0.33)	FDSCS

Luminaire Specifications

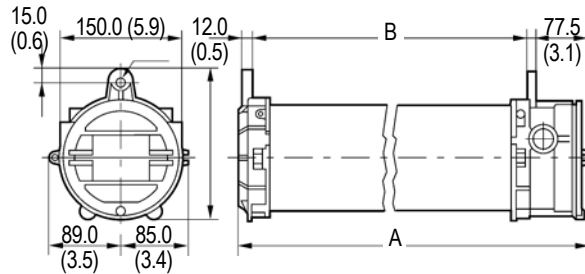

Catalog Number	Dimension A in mm (in)	Dimension B in mm (in)	Weight in kg (lb)	Volume in dm³ (in³)
FDLED25BU2	470 (18.50)	375 (14.76)	8.1 (17.9)	37.1 (2264.0)
FDLED50BU2	745 (29.33)	650 (25.59)	9.0 (19.8)	58.0 (3539.4)
FDLED25BU2DE	470 (18.50)	375 (14.76)	8.1 (17.9)	37.1 (2264.0)
FDLED50BU2DE	745 (29.33)	650 (25.59)	9.0 (19.8)	58.0 (3539.4)