

# Areamaster™ Generation 2 and High Lumen LED Zone 1 Series Luminaires

## Floodlight

### Hazardous Locations

NEC/CEC: Class I, Zone 1 AEx/Ex eb mb Group IIC Gb | Class I, Zone 21 AEx/Ex tb Group IIC Db  
ATEX/IECEx: Zone 1, 2, 21, 22 | Ex eb mb op is IIC | II 2 GD | IP66/67 | IK08

### Applications

- For use in locations where:
  - Hazardous areas designated as: Zone 1, 2, 21 and 22
  - A high degree of corrosion resistance is required
  - Protection against gas, dust, water and moisture is necessary
- Typical applications include:
  - A wide range of harsh and hazardous areas where flammable gases and vapors are present, for example:
    - Oil and Gas Refineries
    - Petrochemical Plants
    - Foundries
    - Drilling Rigs
    - Pulp and Paper Mills
    - Food and Beverage Processing Facilities
    - Loading Docks
    - Power Plants
    - Water and Wastewater Treatment Facilities
    - Hydrogen and Biofuels plants
    - LNG (Liquid Natural Gas) plants
    - Other areas where corrosive, wet, dirty and tough environments are a problem
    - IP66/67; marine and wet locations
    - Extreme hot/cold temperature environments: -40 °C to +55/65 °C (-40 °F to +131/149 °F)



AMLZ



AMHZ

- Guard and visor available, *purchase separately*.
- Slip-fitters and mounting brackets available for easy pole or wall mounting.

### Features

- Six lumen outputs provide up to 38,000 lumens.

Nominal Lumens ①	HID Equivalent	Model Number
9,500	175W-250W	AMLZL6
15,000	250W-400W	AMLZL7
19,500	400W-750W	AMLZL8
24,000	1000W	AMHZL1
30,000	1000-1500W	AMHZL2
38,000	1500W	AMHZL3

① Nominal lumen value for 5000K, NEMA 7x7, with clear glass. Detailed lumen information provided in tables.

- Separate field wiring compartment with screw terminal block for easy and secure connection (can accept UL/CSA 26-10 AWG, 4 to 6 mm<sup>2</sup>).
- Choice of optics for optimal light distribution in a variety of applications.
- Two 3/4" NPT entries provided. Metric M20 adapters available.
- Yoke bracket is designed to accommodate traditional Areamaster brackets and slipfitters for easy retrofit.
- Choice of color temperature (CCT): 5000K (70 CRI) cool white, 4000K (80 CRI) neutral white, or 3000K (80 CRI) warm white.
- Rugged and compact housing with superior thermal design translates to long luminaire life.
- Heavy duty, high temperature silicone rubber gaskets.
- Thermal shock and impact resistant clear or frosted glass lens.
- Standard 6 kV surge protection.
- Captive fasteners secure on piece lens.
- Field replaceable LED driver and lens cover.
- Photobiological safety rating: Risk Group Zero (RG0) with frosted glass; Risk Group One (RG1) with clear glass.
- 5 year standard warranty. 10 year limited warranty for select part number configurations

### Options

- Improved safety cable design with multiple retention points, *purchase separately*.

### Standard Materials

- Housing and lens door: copperfree aluminum (4/10 of 1% maximum)
- Gaskets: silicone rubber
- Yoke: zinc plated HR steel
- Bolts: stainless steel
- Close up plugs: (1) aluminum provided
- Guard and safety cable: stainless steel
- Visor: aluminum

### Standard Finishes

- Housing, lens cover, visor and yoke mount: architectural bronze polyester.

### NEC/CEC Certifications and Compliances

- UL Standards: UL1598; UL 60079-0; UL 60079-7; UL 60079-18; UL 60079-31
- CSA Standards: CSA C22.2 No. 250.0; CAN/CSA C22.2 No. 60079-0; CAN/CSA C22.2 No. 60079-7; CAN/CSA C22.2 No. 60079-18; CAN/CSA C22.2 No. 60079-31
- ETL Report Number: 103761505DAL-001

### ATEX/IECEx Certifications and Compliances

- Certification Type: Areamaster Gen 2
  - Gas: Zone 1 and 2
    - Conforming to ATEX 2014/34/EU: II 2 G
    - Type of Protection: Ex eb mb op is IIC Gb
    - Temperature Class: T6 to T4
  - Dust: Zones 21 and 22
    - Conforming to ATEX 2014/34/EU: II 2 D
    - Type of Protection: Ex op is tb IIIC Db
    - Surface Temperature: +85 °C to +100 °C (-185 °F to +212 °F)
- Ambient Temperature: -40 °C to +65 °C (-40 °F to +149 °F)
- ATEX Certificate: ITS18ATEX303521
- IECEx Certificate: IECEx ITS 18.0031
- Index of Protection according to EN/IEC 60529: IP66/67
- Impact Resistance (shock): IK08
- Photobiological Safety, IEC 62778 and IEC 62471: RG0 with frosted glass, RG1 with clear glass

# Areamaster™ Generation 2 and High Lumen LED Zone 1 Series Luminaires

## Floodlight

Hazardous Locations

NEC/CEC: Class I, Zone 1 AEx/Ex eb mb Group IIC Gb | Class I, Zone 21 AEx/Ex tb Group IIC Db  
ATEX/IECEX: Zone 1, 2, 21, 22 | Ex eb mb op is IIC | II 2 GD | IP66/67 | IK08

---

### Illustrated Features

#### Light Where You Need It

Choose from **3 color temperatures** and a **variety of secondary optics** to put light where your application needs it most. Unsure of which optic is best for your job? Contact your sales representative to get a free 3D Dialux simulation.

#### Robust Design



##### Front-Facing Wiring Compartment:

The Areamaster gasketed front wiring compartment with screw terminal block, and captive screws offers unmatched installation ease and convenience.



##### Replaceable Drivers:

Easy to access, field replaceable drivers extend the useful life of your luminaire up to 200,000 hours or more. Shown above, the Areamaster High Lumen which demands two LED drivers for the very bright outputs up to 38,000 lumens.



##### Visor and Guard:

Whether using to comply with light pollution regulations, or simply controlling your light more and protection your lens, our optional visor and guards are readily available for your applications.

# Areamaster™ Generation 2 and High Lumen LED Zone 1 Series Luminaires

## Floodlight

### Hazardous Locations

NEC/CEC: Class I, Zone 1 AEx/Ex eb mb Group IIC Gb | Class I, Zone 21 AEx/Ex tb Group IIC Db  
ATEX/IECEX: Zone 1, 2, 21, 22 | Ex eb mb op is IIC | II 2 GD | IP66/67 | IK08

#### Order Using Catalog Numbering Guide — Areamaster™ Generation 2 Series Luminaires — Low Lumen Model

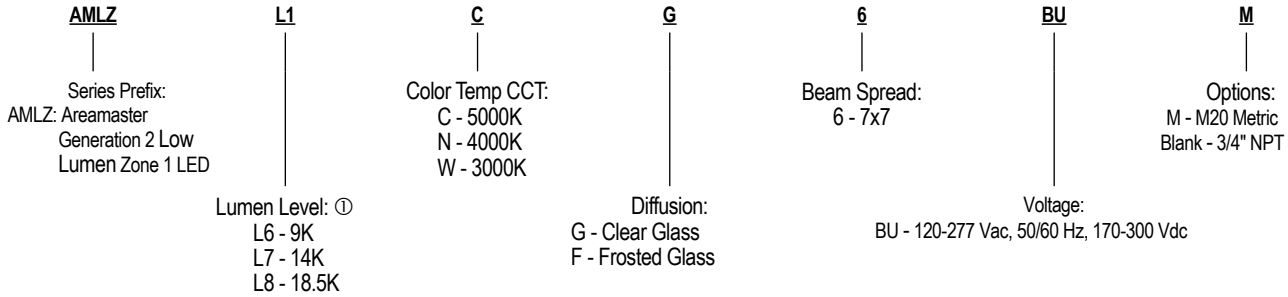

#### Order Using Catalog Numbering Guide — Areamaster™ Generation 2 HL Series Luminaires — High Lumen Model

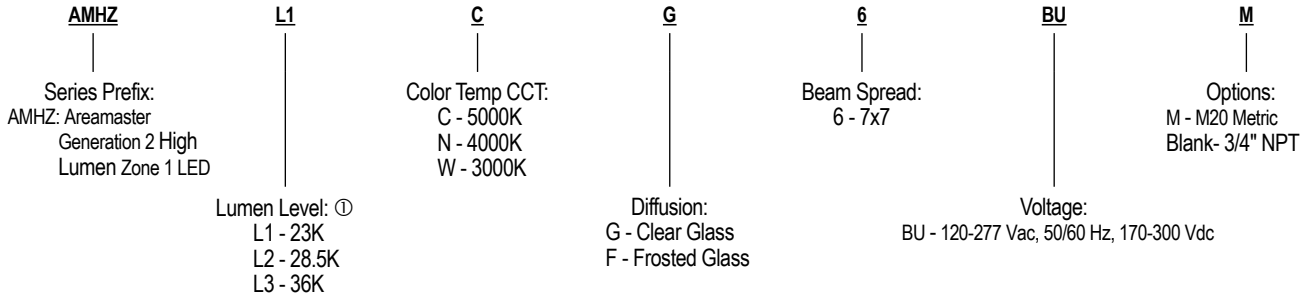

① All lumen values are typical (tolerance +/-10%).

# Areamaster™ Generation 2 and High Lumen LED Zone 1 Series Luminaires

## Floodlight

### Hazardous Locations

NEC/CEC: Class I, Zone 1 AEx/Ex eb mb Group IIC Gb | Class I, Zone 21 AEx/Ex tb Group IIC Db  
ATEX/IECEX: Zone 1, 2, 21, 22 | Ex eb mb op is IIC | II 2 GD | IP66/67 | IK08

#### Lumen Output (Efficacy) — Low Lumen Model ①

Model	HID Equivalency	Light Distribution Pattern	CCT (Correlated Color Temperature)	CRI (Color Rendering Index)	Lumen Output	Efficacy (lm/W)	CCT	CRI	Lumen Output	Efficacy (lm/W)	CCT	CRI	Lumen Output	Efficacy (lm/W)
<b>Clear Glass</b>														
AMLZL6	175-250W	7x7	3000K	80	8,159	125	4000K	80	8,097	124	5000K	70	9,027	139
AMLZL7	250-400W	7x7	3000K	80	12,681	120	4000K	80	12,569	120	5000K	70	14,029	134
AMLZL8	400-750W	7x7	3000K	80	16,364	114	4000K	80	16,221	113	5000K	70	18,104	126
<b>Frosted Glass</b>														
AMLZL6	175-250W	7x7	3000K	80	6,737	104	4000K	80	6,691	102	5000K	70	7,454	115
AMLZL7	250-400W	7x7	3000K	80	10,451	100	4000K	80	10,387	99	5000K	70	11,563	110
AMLZL8	400-750W	7x7	3000K	80	13,553	94	4000K	80	13,465	94	5000K	70	14,993	104

#### Lumen Output (Efficacy) — High Lumen Model ①

Model	HID Equivalency	Light Distribution Pattern	CCT (Correlated Color Temperature)	CRI (Color Rendering Index)	Lumen Output	Efficacy (lm/W)	CCT	CRI	Lumen Output	Efficacy (lm/W)	CCT	CRI	Lumen Output	Efficacy (lm/W)
<b>Clear Glass</b>														
AMHZL1	1000W	7x7	3000K	80	20,670	125	4000K	80	20,205	122	5000K	70	22,556	136
AMHZL2	1000-1500W	7x7	3000K	80	25,281	123	4000K	80	24,708	120	5000K	70	27,588	134
AMHZL3	1500W	7x7	3000K	80	32,231	116	4000K	80	31,488	113	5000K	70	35,171	127
<b>Frosted Glass</b>														
AMHZL1	1000W	7x7	3000K	80	17,179	104	4000K	80	16,838	102	5000K	70	18,746	113
AMHZL2	1000-1500W	7x7	3000K	80	20,948	102	4000K	80	20,531	100	5000K	70	22,859	111
AMHZL3	1500W	7x7	3000K	80	26,733	96	4000K	80	26,203	94.43	5000K	70	29,171	105

① All lumen values are typical (tolerance +/-10%).

# Areamaster™ Generation 2 and High Lumen LED Zone 1 Series Luminaires

## Floodlight

### Hazardous Locations

NEC/CEC: Class I, Zone 1 AEx/Ex eb mb Group IIC Gb | Class I, Zone 21 AEx/Ex tb Group IIC Db  
ATEX/IECEX: Zone 1, 2, 21, 22 | Ex eb mb op is IIC | II 2 GD | IP66/67 | IK08

#### Electrical Specifications ①

Model	Voltage	Input Power (Watts)	Input Current (Amps)	Power Factor (PF)	Total Harmonic Distortion (THD)
<b>Low Lumen Model</b>					
AMLZL6	120 Vac	65	0.6	0.99	< 20%
	277 Vac	63	0.3	0.93	< 20%
	170 Vdc	63	0.5	N/A	N/A
	300 Vdc	63	0.3	N/A	N/A
AMLZL7	120 Vac	105	0.9	0.99	< 20%
	277 Vac	103	0.4	0.94	< 20%
	170 Vdc	103	0.7	N/A	N/A
	300 Vdc	103	0.4	N/A	N/A
AMLZL8	120 Vac	140	1.2	0.99	< 20%
	277 Vac	135	0.5	0.93	< 20%
	170 Vdc	138	0.8	N/A	N/A
	300 Vdc	136	0.5	N/A	N/A
<b>High Lumen Model</b>					
AMHZL1	120 Vac	165	1.4	0.99	< 20%
	277 Vac	161	0.6	0.93	< 20%
	170 Vdc	162	1	N/A	N/A
	300 Vdc	162	0.6	N/A	N/A
AMHZL2	120 Vac	205	1.7	0.99	< 20%
	277 Vac	195	0.8	0.94	< 20%
	170 Vdc	202	1.2	N/A	N/A
	300 Vdc	202	0.7	N/A	N/A
AMHZL3	120 Vac	275	2.4	0.99	< 20%
	277 Vac	265	1	0.94	< 20%
	170 Vdc	270	1.7	N/A	N/A
	300 Vdc	265	0.9	N/A	N/A

Note: Surge Protection: Integral 6 kV surge protection. Option for up to 10 kV surge protection.

① All values are typical (tolerance +/-10%).

# Areamaster™ Generation 2 and High Lumen LED Zone 1 Series Luminaires

## Floodlight

### Hazardous Locations

NEC/CEC: Class I, Zone 1 AEx/Ex eb mb Group IIC Gb | Class I, Zone 21 AEx/Ex tb Group IIC Db  
ATEX/IECEX: Zone 1, 2, 21, 22 | Ex eb mb op is IIC | II 2 GD | IP66/67 | IK08

#### Temperature Codes ①

Model Number	Gas — T Rating			Dust — Surface T°		
	Ta= +40 °C (+104 °F)	Ta= +55 °C (+131 °F)	Ta= +65 °C (+149 °F)	Ta= +40 °C (+104 °F)	Ta= +55 °C (+131 °F)	Ta= +65 °C (+149 °F)
<b>NEC/CEC (AEx/Ex) — Low Lumen Model</b>						
AMLZL6	T6	T5	T5	T6	T6	T6
AMLZL7	T4	T4	T4	T6	T5	T5
AMLZL8	T4	T4	T4	T6	T5	T5
<b>ATEX/IECEX — Low Lumen Model</b>						
AMLZL6	T6	T5	T5	+85 °C (+185)	+85 °C (+185)	+85 °C (+185)
AMLZL7	T4	T4	T4	+85 °C (+185)	+100 °C (+ 212 °F)	+100 °C (+ 212 °F)
AMLZL8	T4	T4	T4	+85 °C (+185)	+100 °C (+ 212 °F)	+100 °C (+ 212 °F)
<b>NEC/CEC (AEx/Ex) — High Lumen Model</b>						
AMHZL1	T5	T4	T4	T6	T5	T5
AMHZL2	T4	T4	T4	T6	T5	T5
AMHZL3	T4	T4	—	T5	T5	—
<b>ATEX/IECEX — High Lumen Model</b>						
AMHZL1	T5	T4	T4	+85 °C (+185)	+100 °C (+ 212 °F)	+100 °C (+ 212 °F)
AMHZL2	T4	T4	T4	+85 °C (+185)	+100 °C (+ 212 °F)	+100 °C (+ 212 °F)
AMHZL3	T4	T4	—	+100 °C (+ 212 °F)	+100 °C (+ 212 °F)	—

#### "T" Numbers Represent the Maximum Internal Temperature ② or Maximum Surface Temperature ③

"T" #	T1	T2	T3	T4	T5	T6
Temp. Range °C (°F)	+301 to +450 (+547 to +842)	+201 to +300 (+394 to +572)	+136 to +200 (+277 to +392)	+101 to +135 (+214 to +275)	+86 to +100 (+187 to +212)	+85 (+185)

① Ambient Temperature Range: -40 °C to +65 °C (-40 °F to +149 °F).

② T numbers represent the maximum internal temperature for Class I, Zone 1 locations designated by the NEC, and Zone 1 (Gas) locations as designated by the IEC.

③ T numbers and surface temperatures represent the maximum surface temperature under a dust blanket for Class I, Zone 21 as designated by the NEC, and Zone 21 (Dust) locations as designated by the IEC.



# Areamaster™ Generation 2 and High Lumen LED Zone 1 Series Luminaires

## Floodlight

### Hazardous Locations

NEC/CEC: Class I, Zone 1 AEx/Ex eb mb Group IIC Gb | Class I, Zone 21 AEx/Ex tb Group IIC Db  
 ATEX/IECEX: Zone 1, 2, 21, 22 | Ex eb mb op is IIC | II 2 GD | IP66/67 | IK08

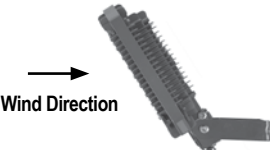
LED Luminaires | Floodlight | Hazardous Location | NEC / CEC / ATEX / IECEx

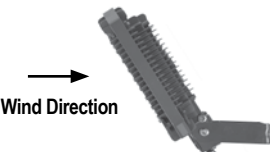
Luminaire Category	Image	Frontal Projected Area (FPA) mm (ft²)	Drag Coefficient (DC)	Effective Projected Area (EPA) = FPA*DC ft² mm (ft²)
<b>Low Lumen Model</b>				
90° to Ground-Worst Case Mounting		0.5 (1.52)	1.20	0.6 (1.82)
45° to Ground-Standard Mounting		0.3 (1.07)	1.20	0.4 (1.28)
<b>High Lumen Model</b>				
90° to Ground-Worst Case Mounting		0.6 (2.04)	1.20	0.75 (2.45)
45° to Ground-Standard Mounting		0.4 (1.44)	1.20	0.5 (1.73)

# Areamaster™ Generation 2 and High Lumen LED Zone 1 Series Luminaires

## Floodlight

### Hazardous Locations

NEC/CEC: Class I, Zone 1 AEx/Ex eb mb Group IIC Gb | Class I, Zone 21 AEx/Ex tb Group IIC Db  
ATEX/IECEX: Zone 1, 2, 21, 22 | Ex eb mb op is IIC | II 2 GD | IP66/67 | IK08

Accessories and Replacement Parts			
	Description	Weight in kg (lbs)	Catalog Number
<b>Crossarm Mounting Bracket</b>			
	Has 180° horizontal adjustment — degree marked. Facilitates mounting floodlight to crossarm or other flat surface, or to GAM8WB. Includes floodlight yoke bolts. Malleable iron, zinc plated, chromate sealed, architectural bronze polyester finish.	1.4 (3.1)	<b>GAM8CA</b>
<b>Pipe or Wall Mount Bracket</b>			
	Used with GAM8CA. Clamps to 1" to 2-1/2" pipe, vertical or horizontal, or mounts on flat surfaces. Includes U-bolt and crossarm bracket bolts. Malleable iron, zinc plated, chromate sealed, with architectural bronze polyester finish.	2.9 (6.4)	<b>GAM8WB</b>
	<i>Crossarm Mounting Bracket (GAM8CA) used with Pipe or Wall Mount Bracket (GAM8WB).</i>		
<b>Poletop Slip-Fitter</b>			
	Slip-fits 1" or 1-1/2" pipe size poletop tenons. Includes floodlight yoke bolts, 3 locking bolts, and cord grip. Body is malleable iron-zinc plated, chromate sealed, with cast aluminum cap. Assembly has architectural bronze polyester finish.	2.4 (5.3)	<b>AMLEDSF1</b>
<b>Poletop Slip-Fitter</b>			
	Slip-fits 2" or 2-1/2" poletop tenons. Includes floodlight yoke bolts, 3 locking bolts, and cord grip. Malleable iron, zinc plated, chromate sealed, with architectural bronze polyester finish.	2.8 (6.2)	<b>GAM8SF</b>

LED Luminaires | Floodlight | Hazardous Location | NEC / CEC / ATEX / IECEX



# Areamaster™ Generation 2 and High Lumen LED Zone 1 Series Luminaires





## Floodlight

### Hazardous Locations

NEC/CEC: Class I, Zone 1 AEx/Ex eb mb Group IIC Gb | Class I, Zone 21 AEx/Ex tb Group IIC Db  
ATEX/IECEX: Zone 1, 2, 21, 22 | Ex eb mb op is IIC | II 2 GD | IP66/67 | IK08

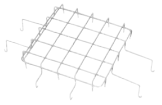
LED Luminaires | Floodlight | Hazardous Location | NEC / CEC / ATEX / IECEX

#### Accessories and Replacement Parts

	Description	Weight in kg (lbs)	Catalog Number
<b>Wall Mount Bracket</b>			
	Used with GAM8SF to provide a wall mounting option. Galvanized Steel.	4.8 (10.5)	<b>GPSWB6GAL</b>
<b>Wire Guard</b>			
	Stainless steel.	0.2 (0.4)	<b>LGGUARD</b> <b>LHGUARD</b>
<b>Safety Cable</b>			
	Stainless steel.	0.2 (0.4)	<b>LEDSC</b>
<b>Visor</b>			
	Steel with architectural bronze polyester finish. For Dark Sky Friendly design.	0.2 (0.4)	<b>AMLGV</b> <b>AMLHV</b>
<b>Portable Floodlight Base</b>			
	Portable floodlight base for temporary lighting applications. To be used with wire guard. Malleable iron with architectural bronze polyester finish.	2.4 (5.2)	<b>GAMPFB</b>
<b>Replacement Covers</b>			
	Clear Glass — AMLZ	N/A	<b>AMLZCLEAR</b>
	Frosted Glass — AMLZ	1.8 (4.0)	<b>AMLZFROST</b>
	Clear Glass — AMHZ	N/A	<b>AMHZCLEAR</b>
	Frosted Glass — AMHZ	N/A	<b>AMHZFROST</b>
<b>Yoke Mount Bracket</b>			
	Stainless Steel Yoke Mount Bracket. For installations requiring a higher degree of corrosion protection. Made with all stainless steel components, no painted finish.	1.8 (4.0)	<b>AMLYMSS</b>
	Architectural Bronze Replacement Yoke Bracket	1.41 (3.1)	<b>AMLYMAB</b>



# Areamaster™ Generation 2 and High Lumen LED Zone 1 Series Luminaires

## Floodlight

### Hazardous Locations

NEC/CEC: Class I, Zone 1 AEx/Ex eb mb Group IIC Gb | Class I, Zone 21 AEx/Ex tb Group IIC Db  
ATEX/IECEX: Zone 1, 2, 21, 22 | Ex eb mb op is IIC | II 2 GD | IP66/67 | IK08

#### Replacement Drivers

	Luminaire Model	Voltage	Driver Wattage	Constant Current Setting	Catalog Number
<b>Low Lumen Model</b>					
	AMLZ6	BU	100 Watt	410mA	APMZ100C090UD41
	AMLZL7	BU	150 Watt	680mA	APMZ150C135UD68
	AMLZL8	BU	150 Watt	930mA	APMZ150C135UD93
<b>High Lumen Model</b>					
	AMHZL1	BU	100 Watt	530mA	APMZ100C090UD53
	AMHZL2	BU	150 Watt	680mA	APMZ150C135UD68
	AMHZL3	BU	150 Watt	915mA	APMZ150C135UD93

#### Luminaire Weight

Description	Weight in kg (lbs)
Low Lumen Model — AMLZ Luminaires	9.8 (21.6)
High Lumen Model — AMHZ Luminaires	16.5 (36.5)

# Areamaster™ Generation 2 and High Lumen LED Zone 1 Series Luminaires

## Floodlight

### Hazardous Locations

NEC/CEC: Class I, Zone 1 AEx/Ex eb mb Group IIC Gb | Class I, Zone 21 AEx/Ex tb Group IIC Db  
 ATEX/IECEX: Zone 1, 2, 21, 22 | Ex eb mb op is IIC | II 2 GD | IP66/67 | IK08

#### AMLZ Dimensions in Millimeters (Inches) — Floodlight — Low Lumen Model

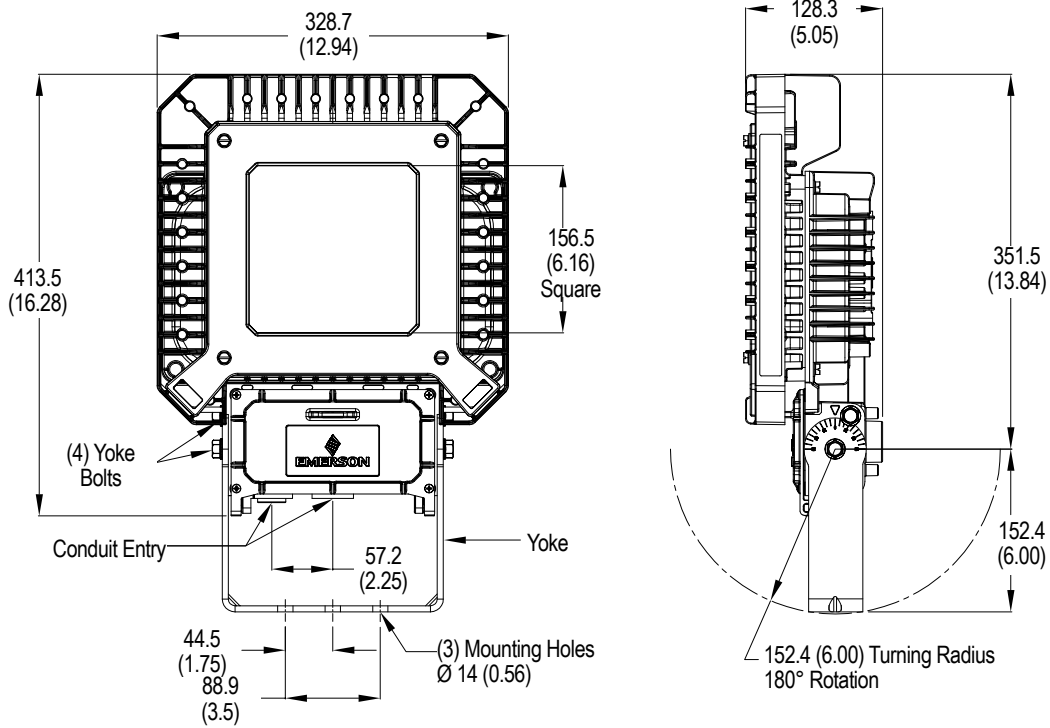

(4) 1/4-20 UNC-2B Thread

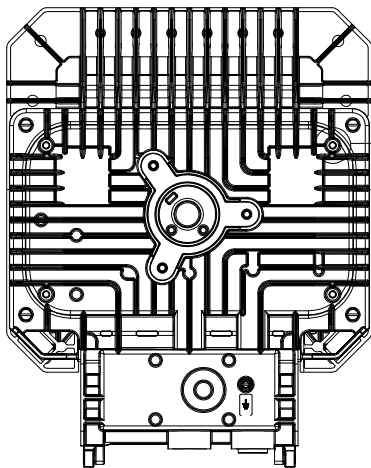

(2) Hubs for 3/4" NPT Conduit or M20 Metric

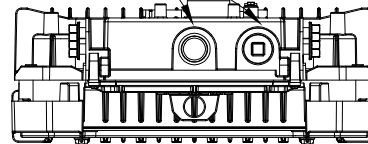

# Areamaster™ Generation 2 and High Lumen LED Zone 1 Series Luminaires

## Floodlight

Hazardous Locations

NEC/CEC: Class I, Zone 1 AEx/Ex eb mb Group IIC Gb | Class I, Zone 21 AEx/Ex tb Group IIC Db  
 ATEX/IECEX: Zone 1, 2, 21, 22 | Ex eb mb op is IIC | II 2 GD | IP66/67 | IK08

### AMHZ Dimensions in Millimeters (Inches)

Floodlight — High Lumen Model

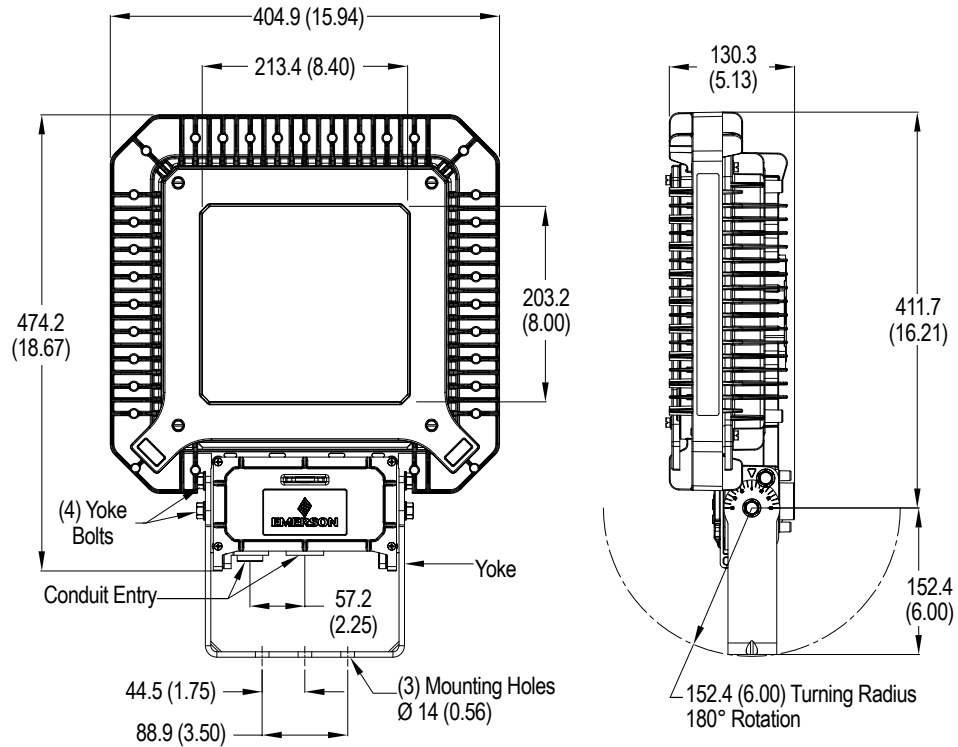

(4) 1/4-20 UNC-2B Thread

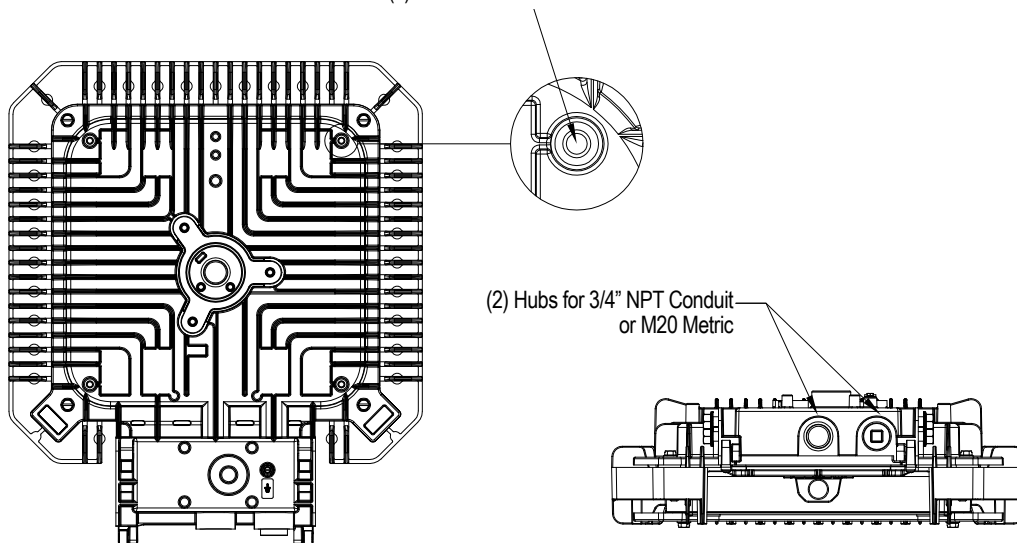

LED Luminaires | Floodlight | Hazardous Location | NEC / CEC / ATEX / IECEx

# Areamaster™ Generation 2 and High Lumen LED Zone 1 Series Luminaires

## Floodlight

### Hazardous Locations

NEC/CEC: Class I, Zone 1 AEx/Ex eb mb Group IIC Gb | Class I, Zone 21 AEx/Ex tb Group IIC Db  
ATEX/IECEX: Zone 1, 2, 21, 22 | Ex eb mb op is IIC | II 2 GD | IP66/67 | IK08

#### Photometric Data — DATA SHOWN IS ABSOLUTE

7x7, Frosted Glass, 5000K CCT

REPORT NUMBER: AMLZL6CF6BUM

Luminaire Lumens 7,454

#### POLAR CANDELA DISTRIBUTION

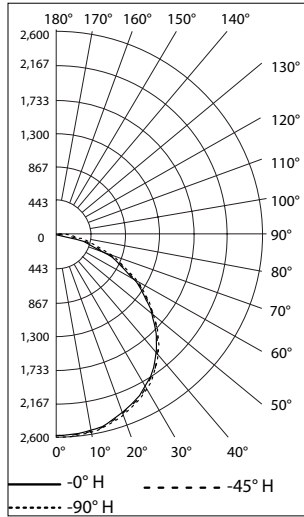

#### ISOLUX PLOT AT 45°

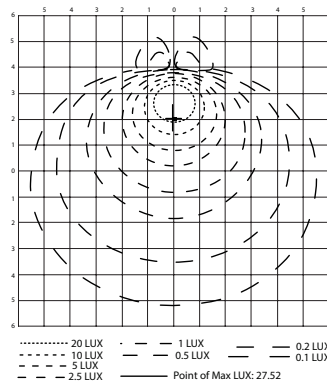

#### FLOOD SUMMARY

	Efficiency	Lumens	Horizontal Spread	Vertical Spread
Field (10%)	97.5%	7,280	159°	157°
Beam (50%)	75.5%	5,640	113°	114°
Total	100%	7,454		

Tilt Angle- 45 Degree LLF-0.9

Mounting Height m (ft)	Forward Throw Distance			
	0.5fc/5lx m (ft)	1fc/11lx m (ft)	2fc/22lx m (ft)	5fc/54lx m (ft)
12 (40)	12 (40)	9 (30)	6 (20)	0
15 (50)	13 (42)	9 (29)	2 (8)	0
18 (60)	12 (40)	5 (16)	0	0

Mounting Height m (ft)	Side-to-Side Distance			
	0.5fc/5lx m (ft)	1fc/11lx m (ft)	2fc/22lx m (ft)	5fc/54lx m (ft)
12 (40)	18 (60)	13 (44)	9 (30)	0
15 (50)	18 (60)	11 (36)	0	0
18 (60)	18 (60)	7 (24)	0	0

7x7, Clear Glass, 5000K

REPORT NUMBER: AMLZL6CG6BUM

Luminaire Lumens 9,027

#### POLAR CANDELA DISTRIBUTION

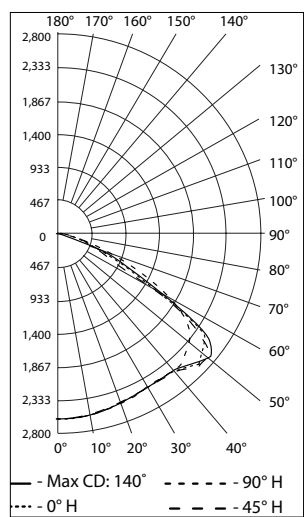

#### ISOLUX PLOT AT 45°

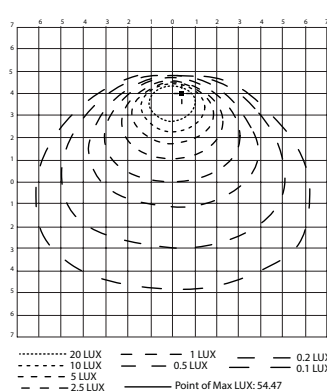

#### FLOOD SUMMARY

	Efficiency	Lumens	Horizontal Spread	Vertical Spread
Field (10%)	98.3%	8,897	134°	144°
Beam (50%)	90.1%	8,153	95°	120°
Total	100%	9,027		

Tilt Angle- 45 Degree LLF-0.9

Mounting Height m (ft)	Forward Throw Distance			
	0.5fc/5lx m (ft)	1fc/11lx m (ft)	2fc/22lx m (ft)	5fc/54lx m (ft)
12 (40)	12 (40)	9 (30)	6 (20)	2 (5)
15 (50)	14 (45)	18 (60)	5 (15)	0
18 (60)	12 (40)	6 (20)	0	0

Mounting Height m (ft)	Side-to-Side Distance			
	0.5fc/5lx m (ft)	1fc/11lx m (ft)	2fc/22lx m (ft)	5fc/54lx m (ft)
12 (40)	22 (72)	15 (50)	12 (40)	3 (10)
15 (50)	22 (72)	16 (54)	9 (30)	0
18 (60)	24 (80)	12 (40)	0	0

LED Luminaires | Floodlight | Hazardous Location | NEC / CEC / ATEX / IECEX

# Areaster™ Generation 2 and High Lumen LED Zone 1 Series Luminaires

## Floodlight

### Hazardous Locations

NEC/CEC: Class I, Zone 1 AEx/Ex eb mb Group IIC Gb | Class I, Zone 21 AEx/Ex tb Group IIC Db  
ATEX/IECEX: Zone 1, 2, 21, 22 | Ex eb mb op is IIC | II 2 GD | IP66/67 | IK08

#### Photometric Data — DATA SHOWN IS ABSOLUTE

7x7, Frosted Glass, 5000K CCT

REPORT NUMBER: AMLZL7CF6BUM

Luminaire Lumens 11,563

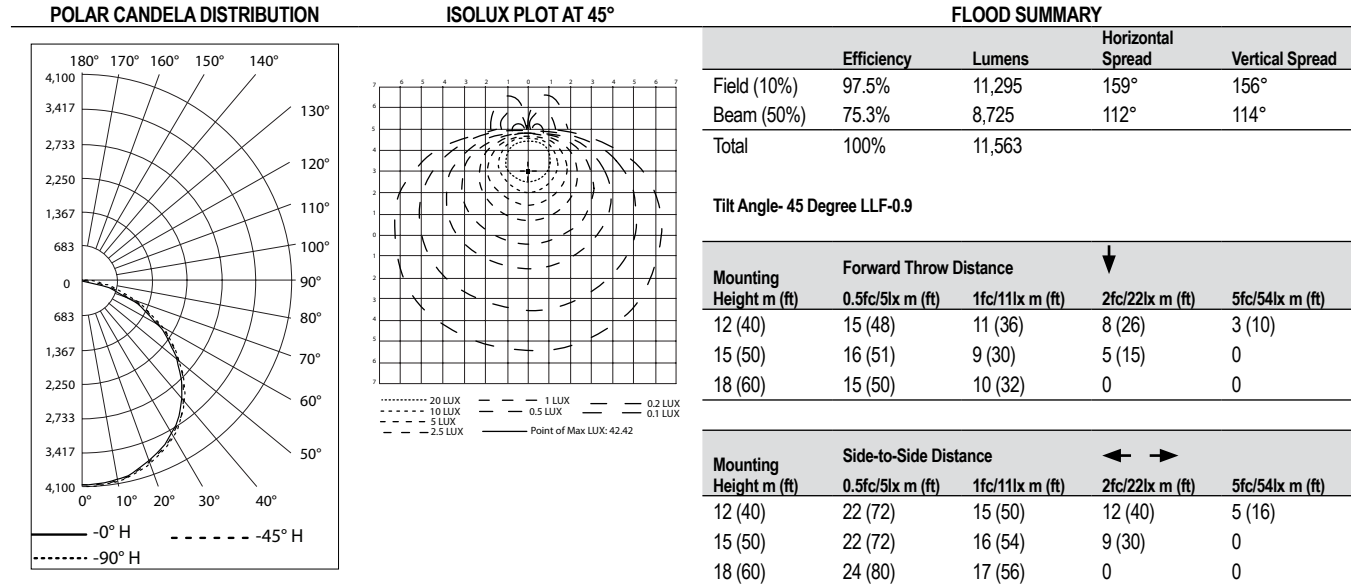

7x7, Clear Glass, 5000K

REPORT NUMBER: AMLZL7CG6BUM

Luminaire Lumens 14,029

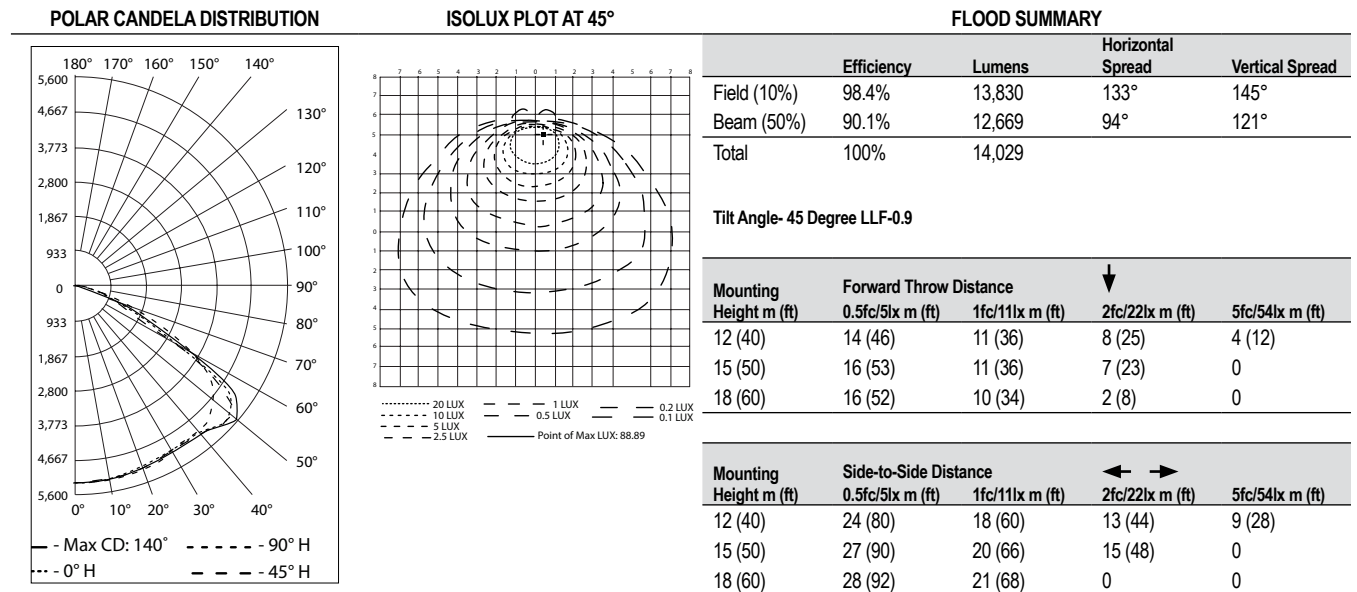

# Areaster™ Generation 2 and High Lumen LED Zone 1 Series Luminaires

## Floodlight

### Hazardous Locations

NEC/CEC: Class I, Zone 1 AEx/Ex eb mb Group IIC Gb | Class I, Zone 21 AEx/Ex tb Group IIC Db  
ATEX/IECEX: Zone 1, 2, 21, 22 | Ex eb mb op is IIC | II 2 GD | IP66/67 | IK08

#### Photometric Data — DATA SHOWN IS ABSOLUTE

7x7, Frosted Glass, 5000K

REPORT NUMBER: AMLZL8CF6BUM

Luminaire Lumens 14,993

LED Luminaires | Floodlight | Hazardous Location | NEC / CEC / ATEX / IECEX

#### POLAR CANDELA DISTRIBUTION

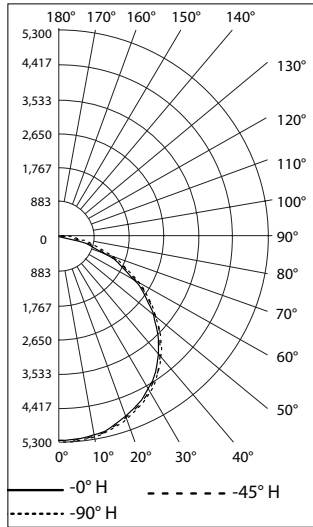

#### ISOLUX PLOT AT 45°

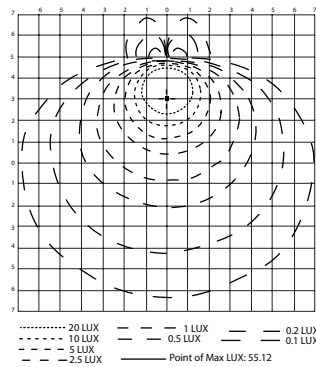

#### FLOOD SUMMARY

	Efficiency	Lumens	Horizontal Spread	Vertical Spread
Field (10%)	97.5%	14,648	159°	156°
Beam (50%)	75.4%	11,323	112°	114°
Total	100%	14,993		

Tilt Angle- 45 Degree LLF-0.9

Mounting Height m (ft)	Forward Throw Distance			
	0.5fc/5lx m (ft)	1fc/11lx m (ft)	2fc/22lx m (ft)	5fc/54lx m (ft)
6 (20)	16 (52)	12 (40)	9 (30)	6 (20)
9 (30)	18 (59)	14 (54)	9 (30)	0
12 (40)	17 (56)	12 (40)	0	0

Mounting Height m (ft)	Side-to-Side Distance			
	0.5fc/5lx m (ft)	1fc/11lx m (ft)	2fc/22lx m (ft)	5fc/54lx m (ft)
6 (20)	23 (76)	18 (60)	13 (44)	6 (20)
9 (30)	26 (84)	18 (60)	14 (45)	0
12 (40)	27 (88)	20 (64)	7 (24)	0

7x7, Clear Glass, 5000K CCT

REPORT NUMBER: AMLZL8CG6BUM

Luminaire Lumens 18,104

#### POLAR CANDELA DISTRIBUTION

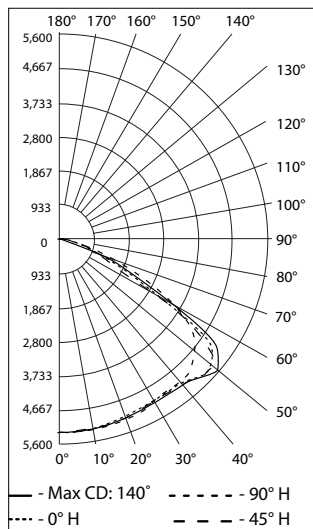

#### ISOLUX PLOT AT 45°

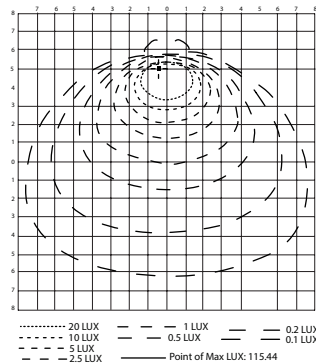

#### FLOOD SUMMARY

	Efficiency	Lumens	Horizontal Spread	Vertical Spread
Field (10%)	98.3%	17,835	132°	145°
Beam (50%)	90%	16,330	93°	121°
Total	100%	18,104		

Tilt Angle- 45 Degree LLF-0.9

Mounting Height m (ft)	Forward Throw Distance			
	0.5fc/5lx m (ft)	1fc/11lx m (ft)	2fc/22lx m (ft)	5fc/54lx m (ft)
6 (20)	16 (52)	12 (40)	9 (30)	5 (18)
9 (30)	9 (30)	13 (42)	9 (30)	0
12 (40)	18 (60)	12 (40)	0	0

Mounting Height m (ft)	Side-to-Side Distance			
	0.5fc/5lx m (ft)	1fc/11lx m (ft)	2fc/22lx m (ft)	5fc/54lx m (ft)
6 (20)	27 (88)	22 (72)	15 (50)	10 (32)
9 (30)	31 (102)	22 (72)	16 (54)	2 (6)
12 (40)	32 (104)	24 (80)	12 (40)	0

# Areaster™ Generation 2 and High Lumen LED Zone 1 Series Luminaires

## Floodlight

### Hazardous Locations

NEC/CEC: Class I, Zone 1 AEx/Ex eb mb Group IIC Gb | Class I, Zone 21 AEx/Ex tb Group IIC Db  
ATEX/IECEX: Zone 1, 2, 21, 22 | Ex eb mb op is IIC | II 2 GD | IP66/67 | IK08

#### Photometric Data — DATA SHOWN IS ABSOLUTE

7x7, Frosted Glass, 5000K CCT

REPORT NUMBER: AMHXL1CF6BUM

Luminaire Lumens 18,746

#### POLAR CANDELA DISTRIBUTION

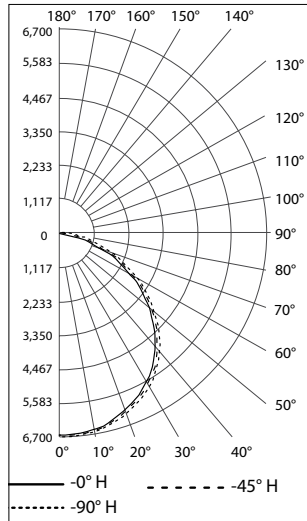

#### ISOLUX PLOT AT 45°

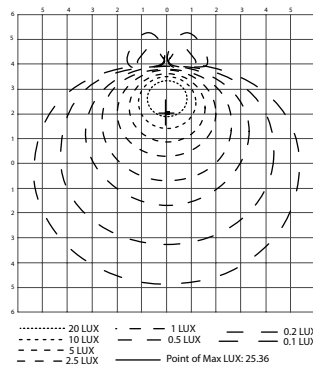

#### FLOOD SUMMARY

	Efficiency	Lumens	Horizontal Spread	Vertical Spread
Field (10%)	97.3%	18,288	159°	159°
Beam (50%)	74.4%	13,978	112°	112°
Total	100%	18,746		

Tilt Angle- 45 Degree LLF-0.9

Mounting Height m (ft)	Forward Throw Distance			
	0.5fc/5lx m (ft)	1fc/11lx m (ft)	2fc/22lx m (ft)	5fc/54lx m (ft)
12 (40)	20 (64)	15 (48)	20 (66)	0
15 (50)	18 (60)	14 (45)	0	0
18 (60)	20 (66)	10 (33)	0	0

Mounting Height m (ft)	Side-to-Side Distance			
	0.5fc/5lx m (ft)	1fc/11lx m (ft)	2fc/22lx m (ft)	5fc/54lx m (ft)
12 (40)	29 (96)	22 (72)	12 (40)	0
15 (50)	30 (100)	18 (60)	0	0
18 (60)	29 (96)	15 (48)	0	0

7x7, Clear Glass, 5000K

REPORT NUMBER: AMHXL1CG6BUM

Luminaire Lumens 22,556

#### POLAR CANDELA DISTRIBUTION

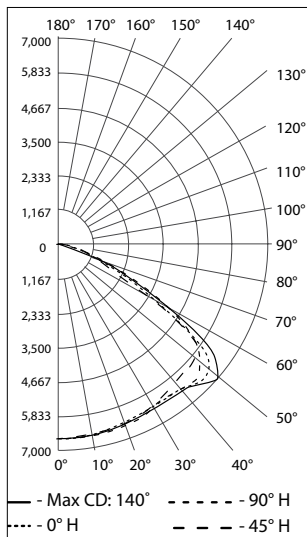

#### ISOLUX PLOT AT 45°

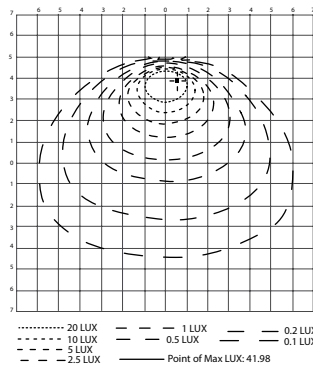

#### FLOOD SUMMARY

	Efficiency	Lumens	Horizontal Spread	Vertical Spread
Field (10%)	98.2%	22,194	137°	142°
Beam (50%)	89.3%	20,186	102°	116°
Total	100%	22,556		

Tilt Angle- 45 Degree LLF-0.9

Mounting Height m (ft)	Forward Throw Distance			
	0.5fc/5lx m (ft)	1fc/11lx m (ft)	2fc/22lx m (ft)	5fc/54lx m (ft)
12 (40)	24 (80)	18 (60)	13 (44)	0
15 (50)	24 (80)	18 (60)	11 (35)	0
18 (60)	27 (90)	18 (60)	0	0

Mounting Height m (ft)	Side-to-Side Distance			
	0.5fc/5lx m (ft)	1fc/11lx m (ft)	2fc/22lx m (ft)	5fc/54lx m (ft)
12 (40)	37 (120)	27 (88)	20 (64)	0
15 (50)	35 (115)	26 (85)	12 (40)	0
18 (60)	37 (120)	26 (84)	0	0



# Areamaster™ Generation 2 and High Lumen LED Zone 1 Series Luminaires

## Floodlight

### Hazardous Locations

NEC/CEC: Class I, Zone 1 AEx/Ex eb mb Group IIC Gb | Class I, Zone 21 AEx/Ex tb Group IIC Db  
ATEX/IECEX: Zone 1, 2, 21, 22 | Ex eb mb op is IIC | II 2 GD | IP66/67 | IK08

#### Photometric Data — DATA SHOWN IS ABSOLUTE

7x7, Frosted Glass, 5000K CCT

REPORT NUMBER: AMHZL2CF6BUM

Luminaire Lumens 22,859

#### POLAR CANDELA DISTRIBUTION

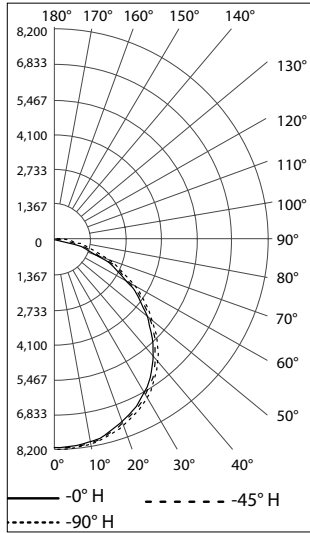

#### ISOLUX PLOT AT 45°

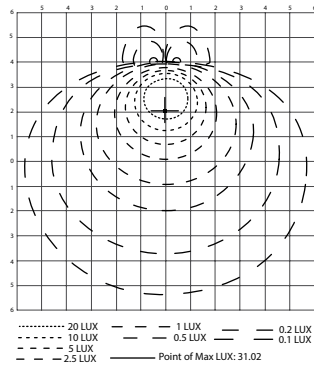

#### FLOOD SUMMARY

	Efficiency	Lumens	Horizontal Spread	Vertical Spread
Field (10%)	97.3%	22,299	159°	157°
Beam (50%)	74.5%	17,064	112°	111°
Total	100%	22,859		

Tilt Angle- 45 Degree LLF-0.9

Mounting Height m (ft)	Forward Throw Distance			
	0.5fc/5lx m (ft)	1fc/11lx m (ft)	2fc/22lx m (ft)	5fc/54lx m (ft)
12 (40)	22 (72)	15 (50)	10 (32)	0
15 (50)	21 (70)	15 (50)	6 (20)	0
18 (60)	22 (72)	15 (48)	0	0

Mounting Height m (ft)	Side-to-Side Distance			
	0.5fc/5lx m (ft)	1fc/11lx m (ft)	2fc/22lx m (ft)	5fc/54lx m (ft)
12 (40)	29 (96)	24 (80)	12 (40)	0
15 (50)	34 (110)	23 (75)	9 (30)	0
18 (60)	33 (108)	18 (60)	0	0

7x7, Clear Glass, 5000K

REPORT NUMBER: AMHZL2CG6BUM

Luminaire Lumens 27,588

#### POLAR CANDELA DISTRIBUTION

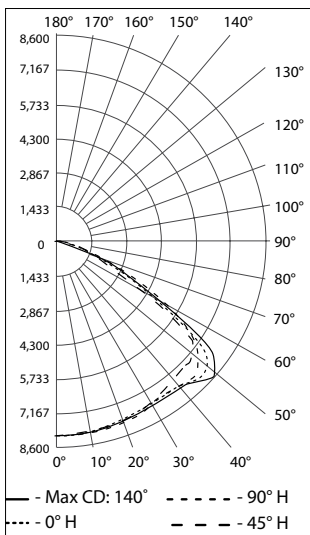

#### ISOLUX PLOT AT 45°

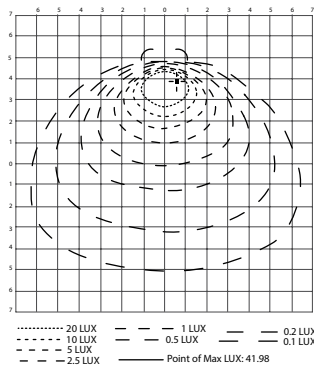

#### FLOOD SUMMARY

	Efficiency	Lumens	Horizontal Spread	Vertical Spread
Field (10%)	98.2%	27,144	137°	142°
Beam (50%)	89.3%	24,676	102°	116°
Total	100%	27,588		

Tilt Angle- 45 Degree LLF-0.9

Mounting Height m (ft)	Forward Throw Distance			
	0.5fc/5lx m (ft)	1fc/11lx m (ft)	2fc/22lx m (ft)	5fc/54lx m (ft)
12 (40)	22 (72)	15 (48)	10 (32)	0
15 (50)	23 (75)	15 (50)	8 (25)	0
18 (60)	22 (72)	15 (48)	0	0

Mounting Height m (ft)	Side-to-Side Distance			
	0.5fc/5lx m (ft)	1fc/11lx m (ft)	2fc/22lx m (ft)	5fc/54lx m (ft)
12 (40)	37 (120)	29 (96)	20 (64)	0
15 (50)	37 (120)	30 (100)	15 (50)	0
18 (60)	40 (132)	29 (96)	0	0

LED Luminaires | Floodlight | Hazardous Location | NEC / CEC / ATEX / IECEX

# Areamaster™ Generation 2 and High Lumen LED Zone 1 Series Luminaires

## Floodlight

### Hazardous Locations

NEC/CEC: Class I, Zone 1 AEx/Ex eb mb Group IIC Gb | Class I, Zone 21 AEx/Ex tb Group IIC Db  
ATEX/IECEX: Zone 1, 2, 21, 22 | Ex eb mb op is IIC | II 2 GD | IP66/67 | IK08

#### Photometric Data — DATA SHOWN IS ABSOLUTE

7x7, Frosted Glass, 5000K CCT

REPORT NUMBER: AMHZL3CF6BUM

Luminaire Lumens 29,171

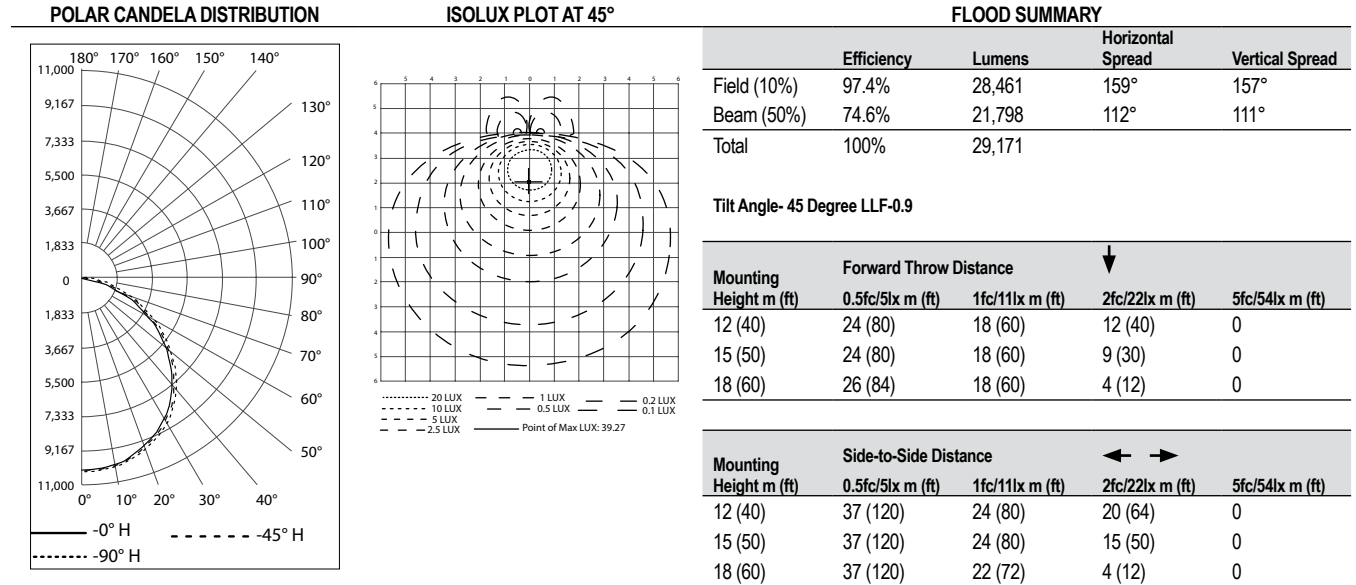

7x7, Clear Glass, 5000K

REPORT NUMBER: AMHZL3CG6BUM

Luminaire Lumens 35,171

