

# Areamaster™ Generation 2 and High Lumen LED Series Luminaires

## Floodlight

### Hazardous Locations

NEC/CEC: Class I, Division 2, Groups A, B, C, D | Class II, Division 1, Groups E, F, G | Class II, Division 2, Groups F, G | Class III | Zone 20, 21 and 22 | Class I, Zone 2 AEx/Ex ec IIC Gc | Zone 21, AEx/Ex tb IIC Db | Type 3R, 4 and 4X | IP66/67 | Simultaneous Exposure | Marine Outside Type (Salt Water) for USA Only | Wet Locations  
ATEX/IECEX: Zone 2, 21, 22 | II 2D 3G 3D | IK08 | IP66  
Markings: CE | UKCA  
Notable: American Bureau of Shipping (ABS) Certified | 10G Vibration

### Applications

- Enclosed and gasketed fixtures suitable for use in a wide range of industrial, chemical processing and other areas where flammable gases and vapors are present, for example:
  - Oil and Gas Refineries
  - Petrochemical Plants
  - Foundries
  - Drilling Rigs
  - Pulp and Paper Mills
  - Food and Beverage Processing Facilities
  - Loading Docks
  - Power Plants
  - Water and Wastewater Treatment Facilities
  - Hydrogen and Biofuels plants
  - LNG (Liquid Natural Gas) plants
  - Other areas where corrosive, wet, dirty and tough environments are a problem
- IP66/IP67, Type 4X, marine and wet locations. IP66 for IECEX/ATEX.
- Locations requiring dependable, consistent lighting in extreme hot/cold temperature environments.
  - 40 °C to +65 °C (-40 °F to +149 °F) ambient temperature range.
  - 40 °C to +55 °C (-40 °F to +131 °F) for high lumen AMLHL3 output.
- Globally rated luminaires with all applicable certification labels for NEC/CEC and ATEX/IECEX environments. See Certifications and Compliances for details.

### Features

- Six lumen outputs provide up to 38,000 lumens.

Nominal Lumens ①	HID Equivalent	Model Number
9,500	175W-250W	AMLGL6
15,000	250W-400W	AMLGL7
19,500	400W-750W	AMLGL8
24,000	1000W	AMLHL1
30,000	1000-1500W	AMLHL2
38,000	1500W	AMLHL3

① Nominal lumen value for 5000K, NEMA 7x7, with clear glass. Detailed lumen information provided in tables.

- Choice of optics for optimal light distribution in a variety of applications.
- Separate field wiring compartment with screw terminal block for easy and secure connection can accept 0.14 - 6 mm<sup>2</sup> (26 - 10 AWG) wire.
- Wiring compartment has two 3/4" NPT entries in bottom and one 3/4" NPT entry on top. Optional M20 metric adapters available.
- High Bay mounting achieved by using 3/4" NPT threaded non-penetrating blind hold centered in top of luminaire with integral set screw. Wire via wiring compartment.
- Yoke bracket is designed to accommodate traditional Areamaster brackets and slipfitters for easy retrofit. Optional stainless steel yoke bracket is available.
- Choice of color temperature (CCT): 5000K (70 CRI) cool white, 4000K (80 CRI) neutral white, or 3000K (80 CRI) warm white.
- Reported L70 is > 60,000 hours @ +65°C (+149 °F).
- Rugged and compact housing with superior thermal design translates to long luminaire life.
- Heavy duty, high temperature silicone rubber gaskets.
- Thermal shock and impact resistant clear or frosted glass lens.
- Standard 6 kV/3 kA surge protection. Optional 10 kV/5 kA additional surge protection available.



AMLG



AMLH

- Captive fasteners secure one piece lens.
- Field replaceable LED driver and lens cover.
- Photometric data and electronic drawings available upon request.
- 5 year standard warranty. 10 year limited warranty for select part number configurations.

### Options

- Improved safety cable design with multiple retention points, *purchase separately*.
- Guard and visor available, *purchase separately*.
- Slip-fitters and mounting brackets available for easy pole or wall mounting.
- Stainless steel yoke bracket.
- 10 kV/5 kA Surge Protection, for NEC/CEC only.

### Standard Materials

- Housing and lens cover: copperfree (4/10 of 1% max.) aluminum
- Gaskets: silicone rubber
- Yoke: zinc plated steel
- Bolts: stainless steel
- Close up plugs: (2) aluminum provided
- Guard and safety cable: stainless steel
- Visor: Aluminum

### Standard Finishes

- Housing, lens cover, visor and yoke mount: architectural bronze polyester

### NEC/CEC Certifications and Compliances

- UL Standards: UL 844; UL1598; UL1598A; UL 8750
- CSA Standards: CSA C22.2 No. 250.0; CSA C22.2 No. 137
- cCSAus 164460 Certificate Number: AMLG – 70073611, AMLH – 70073613
- cETLus: 104364566CHI
- Vibration Rating: 10G, 10 hours, 3 axis at first mode resonant frequency

# Areamaster™ Generation 2 and High Lumen LED Series Luminaires

## Floodlight

### Hazardous Locations

NEC/CEC: Class I, Division 2, Groups A, B, C, D | Class II, Division 1, Groups E, F, G | Class II, Division 2, Groups F, G | Class III | Zone 20, 21 and 22 | Class I, Zone 2 AEx/Ex ec IIC Gc | Zone 21, AEx/Ex tb IIIC Db | Type 3R, 4 and 4X | IP66/67 | Simultaneous Exposure | Marine Outside Type (Salt Water) for USA Only | Wet Locations  
ATEX/IECEx: Zone 2, 21, 22 | II 2D 3G 3D | IK08 | IP66  
Markings: CE | UKCA  
Notable: American Bureau of Shipping (ABS) Certified | 10G Vibration

### ATEX/IECEx Certifications and Compliances

- Certification Type: Areamaster Generation 2 and High Lumen LED
  - Gas: Zone 2
    - Conforming to ATEX 2014/34/EU: II 3G
    - Type of Protection: Ex ec IIC Gc
    - Temperature Class: AMLG – T5 to T3; AMLH – T4 to T3
  - Dust: Zones 21 and 22
    - Conforming to ATEX 2014/34/EU: II 2D
    - Type of Protection: Ex op is tb IIIC Db
    - Surface Temperature: +85 °C to +100 °C (+185 °F to +212 °F)
  - Dust: Zone 22
    - Conforming to ATEX 2014/34/EU: II 3D
    - Type of Protection: Ex to IIIC Dc
    - Surface Temperature: +85 °C to +100 °C (+185 °F to +212 °F)
- Ambient Temperature: -40 °C up to +65 °C (-40 °F up to +149 °F). -40 °C to +55 °C (-40 °F to +131 °F) for high lumen AMLHL3 output.
- ATEX Certificates: ITS18ATEX104171, ITS18ATEX304055
- IECEx Certificate: IECEx ITS 18.0049
- Index of Protection according EN/IEC 60529: IP66
- Impact Resistance (shock): IK08
- Photobiological Safety, IEC 62778 and IEC 62471: Risk Group 1 (RG1)

### CE and UKCA Marking

- ATEX: EN 60079-0, EN 60079-7, EN 60079-31
- Safety: EN 60598-1, EN 60598-2-1, and EN 60598-2-5
- EMC: EN 61547, 61000-6-2, 61000-6-4, 61000-3-2; CISPR 15

### ABS Certifications

- AMLG: 18-HS1714271-PDA
- AMLH: 18-HS1714275-PDA

### DesignLights™ Consortium

- Check DLC QPL for current list of products.

### Related Products

- Industrial Areamaster Generation 2 and High Lumen LED Series Luminaires
- Round Tapered Steel Poles
- Hinged Steel Poles
- Square Tapered Steel Poles
- Square Steel Poles
- Floodlight Mounting Brackets

### Illustrated Features

#### Light Where You Need It

Choose from **3 color temperatures** and a **variety of secondary optics** to put light where your application needs it most. Unsure of which optic is best for your job? Contact your sales representative to get a free 3D Dialux simulation.

#### The Right Beam Pattern for Your Application

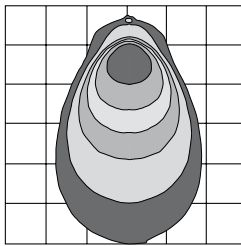

**NEMA 3x3** – Very Narrow, spot type forward intensity focus. Enables highest mounting heights (30 m / 100 ft +) while maintaining delivered light on surface (footcandles/lux).

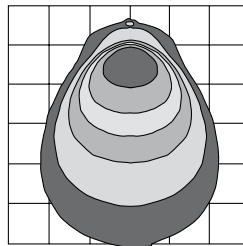

**NEMA 5x5** – Narrow, spot type forward intensity focus. Enables higher mounting heights (15 m / 50 ft +) while maintaining delivered light on surface (footcandles/lux).

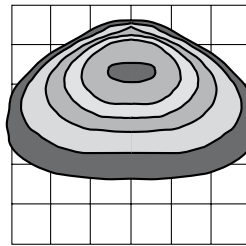

**NEMA 7x6** – Mimics traditional HID light distribution. Light intensity is directed forward and side-to-side to maximize spacing between luminaires.

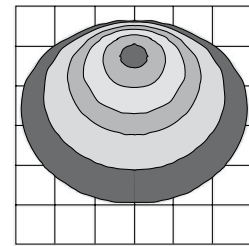

**NEMA 7x7** – Uniform light spread, perfect for most typical flood lighting applications.

### Robust Design



**Front-Facing Wiring Compartment:** Gasketed front wiring compartment with screw terminal block, and captive screws offers unmatched installation ease and convenience.

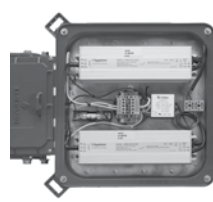

**Replaceable Drivers:** Easy to access, field replaceable drivers extend the useful life of your luminaire up to 200,000 hours or more.



**Visor and Guard:** Comply with light pollution regulations or control light spread with a visor. Protect the lens with a guard.



**High Bay Mount:** Use 3/4" NPT threaded non-penetrating blind hold centered in top of luminaire with integral set screw. Wire via wiring compartment.

# Areamaster™ Generation 2 and High Lumen LED Series Luminaires

## Floodlight

### Hazardous Locations

NEC/CEC: Class I, Division 2, Groups A, B, C, D | Class II, Division 1, Groups E, F, G | Class II, Division 2, Groups F, G | Class III | Zone 20, 21 and 22 | Class I, Zone 2 AEx/Ex ec IIC Gc | Zone 21, AEx/Ex tb IIIC Db | Type 3R, 4 and 4X | IP66/67 | Simultaneous Exposure | Marine Outside Type (Salt Water) for USA Only | Wet Locations  
 ATEX/IECEX: Zone 2, 21, 22 | II 2D 3G 3D | IK08 | IP66  
 Markings: CE | UKCA  
 Notable: American Bureau of Shipping (ABS) Certified | 10G Vibration

### Order Using Catalog Numbering Guide — Areamaster™ Generation 2 Series Luminaires — Low Lumen Model

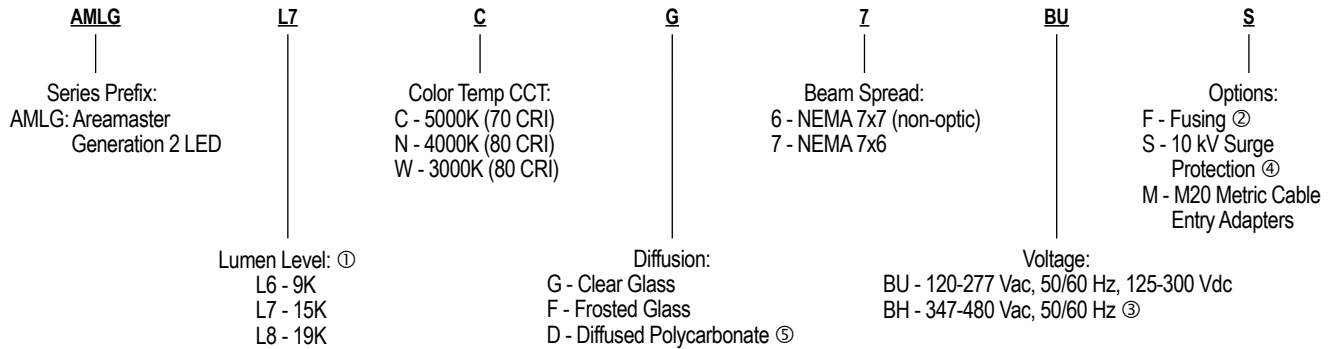

### Order Using Catalog Numbering Guide — Areamaster™ Generation 2 Series Luminaires — High Lumen Model

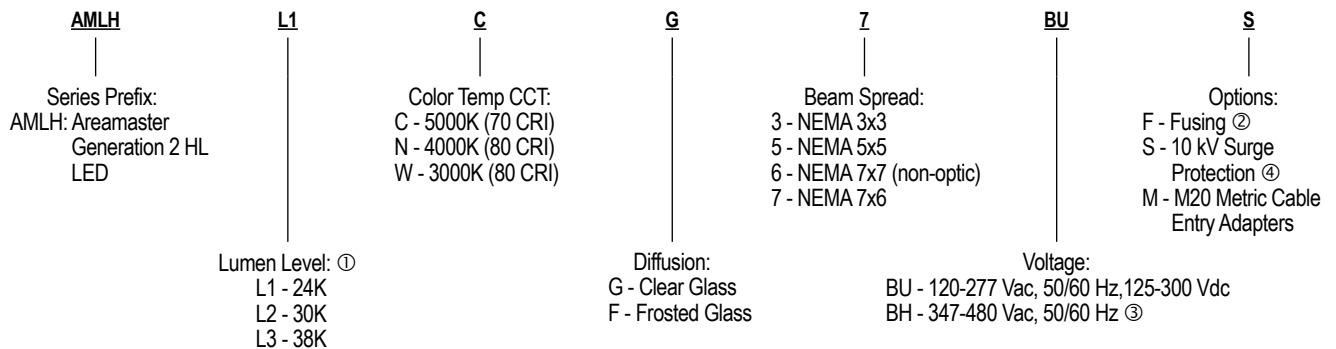

① All lumen values are typical (tolerance +/- 10%)  
 ② Use of fuse voids Marine rating. Fusing available for NEC/CEC only.  
 ③ BH voltage available for NEC/CEC only.  
 ④ 10kV Surge Protection available for NEC/CEC only.  
 ⑤ Diffused polycarbonate available for NEC/CEC only.

# Areaster™ Generation 2 and High Lumen LED Series Luminaires

## Floodlight

### Hazardous Locations

NEC/CEC: Class I, Division 2, Groups A, B, C, D | Class II, Division 1, Groups E, F, G | Class II, Division 2, Groups F, G | Class III | Zone 20, 21 and 22 | Class I, Zone 2 AEx/Ex ec IIC Gc |

Zone 21, AEx/Ex tb IIC Db | Type 3R, 4 and 4X | IP66/67 | Simultaneous Exposure | Marine Outside Type (Salt Water) for USA Only | Wet Locations

ATEX/IECEX: Zone 2, 21, 22 | II 2D 3G 3D | IK08 | IP66

Markings: CE | UKCA

Notable: American Bureau of Shipping (ABS) Certified | 10G Vibration

LED Luminaires | Floodlight | Hazardous Location | NEC / CEC / ATEX / IECEX

#### Lumen Output (Efficacy) — Low Lumen Model ①

Model	HID Equivalency	Light Distribution Pattern	CCT (Correlated Color Temperature)	CRI (Color Rendering Index)	Lumen Output	Efficacy (lm/W)	CCT	CRI	Lumen Output	Efficacy (lm/W)	CCT	CRI	Lumen Output	Efficacy (lm/W)
<b>Clear Glass</b>														
AMLGL6	175-250W	NEMA 7x6	3000K	80	7,350	105	4000K	80	8,500	121	5000K	70	9,500	136
		NEMA 7x7	3000K	80	7,650	109	4000K	80	9,000	129	5000K	70	9,900	141
AMLGL7	250-400W	NEMA 7x6	3000K	80	11,000	99	4000K	80	12,950	117	5000K	70	14,500	131
		NEMA 7x7	3000K	80	11,500	104	4000K	80	13,650	123	5000K	70	15,000	135
AMLGL8	400-750W	NEMA 7x6	3000K	80	14,500	95	4000K	80	16,550	109	5000K	70	18,500	122
		NEMA 7x7	3000K	80	15,000	99	4000K	80	17,550	115	5000K	70	19,500	128
<b>Frosted Glass</b>														
AMLGL6	175-250W	NEMA 7x6	3000K	80	6,200	89	4000K	80	7,200	103	5000K	70	7,900	113
		NEMA 7x7	3000K	80	6,400	91	4000K	80	7,500	107	5000K	70	8,300	119
AMLGL7	250-400W	NEMA 7x6	3000K	80	9,400	85	4000K	80	10,950	99	5000K	70	12,000	108
		NEMA 7x7	3000K	80	9,700	87	4000K	80	11,350	102	5000K	70	12,500	113
AMLGL8	400-750W	NEMA 7x6	3000K	80	12,000	79	4000K	80	14,000	92	5000K	70	15,550	102
		NEMA 7x7	3000K	80	12,500	82	4000K	80	14,500	95	5000K	70	16,550	109
<b>Diffused Polycarbonate</b>														
AMLGL6	175-250W	NEMA 7x6	3000K	80	5,950	85	4000K	80	6,950	99	5000K	70	7,700	110
		NEMA 7x7	3000K	80	6,250	89	4000K	80	7,300	104	5000K	70	8,050	115
AMLGL7	250-400W	NEMA 7x6	3000K	80	9,000	81	4000K	80	10,550	95	5000K	70	11,700	105
		NEMA 7x7	3000K	80	9,450	85	4000K	80	11,000	99	5000K	70	12,200	110
AMLGL8	400-750W	NEMA 7x6	3000K	80	11,500	76	4000K	80	13,500	89	5000K	70	15,000	99
		NEMA 7x7	3000K	80	12,100	80	4000K	80	14,150	93	5000K	70	15,650	103

① All lumen values are typical (tolerance +/-10%).

# Areaster™ Generation 2 and High Lumen LED Series Luminaires

## Floodlight

### Hazardous Locations

NEC/CEC: Class I, Division 2, Groups A, B, C, D | Class II, Division 1, Groups E, F, G | Class II, Division 2, Groups F, G | Class III | Zone 20, 21 and 22 | Class I, Zone 2 AEx/Ex ec IIC Gc | Zone 21, AEx/Ex tb IIC Db | Type 3R, 4 and 4X | IP66/67 | Simultaneous Exposure | Marine Outside Type (Salt Water) for USA Only | Wet Locations  
 ATEX/IECEX: Zone 2, 21, 22 | II 2D 3G 3D | IK08 | IP66  
 Markings: CE | UKCA  
 Notable: American Bureau of Shipping (ABS) Certified | 10G Vibration

#### Lumen Output (Efficacy) — High Lumen Model ①

Model	HID Equivalency	Light Distribution Pattern	CCT (Correlated Color Temperature)	CRI (Color Rendering Index)	Lumen Output	Efficacy (lm/W)	CCT	CRI	Lumen Output	Efficacy (lm/W)	CCT	CRI	Lumen Output	Efficacy (lm/W)
<b>Clear Glass</b>														
AMLHL1	1000W	NEMA 3x3	3000K	80	19,350	109	4000K	80	20,250	114	5000K	70	22,750	128
		NEMA 5x5	3000K	80	20,850	117	4000K	80	21,900	123	5000K	70	25,000	140
		NEMA 7x6	3000K	80	19,000	107	4000K	80	20,500	115	5000K	70	23,000	129
		NEMA 7x7	3000K	80	20,100	113	4000K	80	21,300	120	5000K	70	24,250	136
AMLHL2	1000-1500W	NEMA 3x3	3000K	80	23,450	106	4000K	80	24,600	111	5000K	70	27,500	124
		NEMA 5x5	3000K	80	25,500	115	4000K	80	26,700	120	5000K	70	30,000	135
		NEMA 7x6	3000K	80	23,200	105	4000K	80	25,000	113	5000K	70	27,950	126
		NEMA 7x7	3000K	80	24,650	111	4000K	80	26,100	118	5000K	70	29,750	134
AMLHL3	1500W	NEMA 3x3	3000K	80	29,500	99	4000K	80	30,950	104	5000K	70	34,750	117
		NEMA 5x5	3000K	80	32,000	107	4000K	80	33,600	113	5000K	70	37,500	126
		NEMA 7x6	3000K	80	29,300	98	4000K	80	31,500	106	5000K	70	35,350	119
		NEMA 7x7	3000K	80	31,000	104	4000K	80	32,800	110	5000K	70	37,400	126
<b>Frosted Glass</b>														
AMLHL1	1000W	NEMA 3x3	3000K	80	17,200	97	4000K	80	17,950	101	5000K	70	20,000	112
		NEMA 5x5	3000K	80	18,600	104	4000K	80	19,350	109	5000K	70	21,550	121
		NEMA 7x6	3000K	80	16,150	91	4000K	80	17,300	97	5000K	70	19,500	110
		NEMA 7x7	3000K	80	16,850	95	4000K	80	18,000	101	5000K	70	20,500	115
AMLHL2	1000-1500W	NEMA 3x3	3000K	80	21,000	95	4000K	80	21,950	99	5000K	70	24,750	111
		NEMA 5x5	3000K	80	22,650	102	4000K	80	23,600	106	5000K	70	26,000	117
		NEMA 7x6	3000K	80	19,600	88	4000K	80	21,000	95	5000K	70	23,700	107
		NEMA 7x7	3000K	80	20,550	93	4000K	80	21,950	99	5000K	70	25,000	113
AMLHL3	1500W	NEMA 3x3	3000K	80	26,400	89	4000K	80	27,500	92	5000K	70	31,000	104
		NEMA 5x5	3000K	80	28,600	96	4000K	80	29,750	100	5000K	70	33,500	112
		NEMA 7x6	3000K	80	24,750	83	4000K	80	26,550	89	5000K	70	29,950	101
		NEMA 7x7	3000K	80	26,000	87	4000K	80	27,700	93	5000K	70	31,500	106

① All lumen values are typical (tolerance +/-10%).

# Areaster™ Generation 2 and High Lumen LED Series Luminaires

## Floodlight

### Hazardous Locations

NEC/CEC: Class I, Division 2, Groups A, B, C, D | Class II, Division 1, Groups E, F, G | Class II, Division 2, Groups F, G | Class III | Zone 20, 21 and 22 | Class I, Zone 2 AEx/Ex ec IIC Gc | Zone 21, AEx/Ex tb IIC Db | Type 3R, 4 and 4X | IP66/67 | Simultaneous Exposure | Marine Outside Type (Salt Water) for USA Only | Wet Locations  
 ATEX/IECEX: Zone 2, 21, 22 | II 2D 3G 3D | IK08 | IP66  
 Markings: CE | UKCA  
 Notable: American Bureau of Shipping (ABS) Certified | 10G Vibration

#### Electrical Specifications ①

Model	Voltage	Input Power (Watts)	Input Current (Amps)	Power Factor (PF)	Total Harmonic Distortion (THD)
<b>Low Lumen Model</b>					
AMLGL6	120 Vac	73	0.62	>.9	<20%
	277 Vac	71	0.27		
	125 Vdc	69	0.55	N/A	N/A
	300 Vdc	68	0.23		
	347 Vac	71	0.21	>.9	<20%
	480 Vac	71	0.16		
AMLGL7	120 Vac	111	0.94	>.9	<20%
	277 Vac	106	0.43		
	125 Vdc	113	0.90	N/A	N/A
	300 Vdc	111	0.37		
	347 Vac	115	0.33	>.9	<20%
	480 Vac	115	0.25		
AMLGL8	120 Vac	154	1.30	>.9	<20%
	277 Vac	146	0.56		
	125 Vdc	156	1.25	N/A	N/A
	300 Vdc	152	0.51		
	347 Vac	150	0.43	>.9	<20%
	480 Vac	149	0.32		
<b>High Lumen Model</b>					
AMLHL1	120 Vac	180	1.52	>.9	<20%
	277 Vac	176	0.67		
	125 Vdc	172	1.38	N/A	N/A
	300 Vdc	170	0.57		
	347 Vac	179	0.52	>.9	<20%
	480 Vac	179	0.39		
AMLHL2	120 Vac	231	1.94	>.9	<20%
	277 Vac	231	0.88		
	125 Vdc	220	1.76	N/A	N/A
	300 Vdc	217	0.72		
	347 Vac	219	0.64	>.9	<20%
	480 Vac	219	0.47		
AMLHL3	120 Vac	317	2.67	>.9	<20%
	277 Vac	303	1.15		
	125 Vdc	305	2.44	N/A	N/A
	300 Vdc	298	0.99		
	347 Vac	299	0.87	>.9	<20%
	480 Vac	298	0.63		

Note: Surge Protection: Integral 6 kV surge protection. Option for up to 10 kV surge protection.

① All values are typical (tolerance +/-10%).

# Areamaster™ Generation 2 and High Lumen LED Series Luminaires

## Floodlight

### Hazardous Locations

NEC/CEC: Class I, Division 2, Groups A, B, C, D | Class II, Division 1, Groups E, F, G | Class II, Division 2, Groups F, G | Class III | Zone 20, 21 and 22 | Class I, Zone 2 AEx/Ex ec IIC Gc | Zone 21, AEx/Ex tb IIIC Db | Type 3R, 4 and 4X | IP66/67 | Simultaneous Exposure | Marine Outside Type (Salt Water) for USA Only | Wet Locations  
 ATEX/IECEX: Zone 2, 21, 22 | II 2D 3G 3D | IK08 | IP66  
 Markings: CE | UKCA  
 Notable: American Bureau of Shipping (ABS) Certified | 10G Vibration

#### NEC/CEC Temperature Codes

Model	Max Driver Current (mA)	Max Ambient C° (F°)	Gas		Dust		Combined Class I, Division 2 and Class II, Division 1	Gas Ex ec IIC, Class I, Zone 2, AEx ec IIC	Dust Ex tb IIIC, Zone 21, AEx tb IIIC
			Class I, Division 2 Groups A, B, C, D	Class I, Zone 2 Group IIC	Class II, Division 1 Groups E, F, G	Zone 20 Group IIIC			
AMLGL6	410	40 (104)	T5	T5	T6	T6	T4A	T5	T85 °C
		55 (131)	T4A	T4	T6	T6	T4A	T4	T85 °C
		65 (149)	T4A	T4	T6	T6	T4	T4	T85 °C
AMLGL7	680	40 (104)	T4	T4	T6	T6	T4	T4	T85 °C
		55 (131)	T3C	T3	T6	T6	T3C	T3	T85 °C
		65 (149)	T3C ①	T3 ①	T5 ①	T5 ①	T3C ①	T3 ②	T100 °C ②
AMLGL8	930	40 (104)	T3C	T3	T6	T6	T3C	T3	T85 °C
		55 (131)	T3B ①	T3 ①	T5 ①	T5 ①	T3A ①	T3 ①	T100 °C ②
		65 (149)	T3A ①	T3 ①	T5 ①	T5 ①	T3A ①	T3 ①	T100 °C ②
AMLHL1	530	40 (104)	T4A	T4	T6/T5 ③	T6/T5 ③	T4A	T4	T85°C/T100°C ③
		55 (131)	T4A	T4	T6/T5 ③	T6/T5 ③	T4A	T4	T85°C/T100°C ③
		65 (149)	T4	T4	T5 ③	T5 ③	T4	T4	T100°C
AMLHL2	680	40 (104)	T4	T4	T6/T5 ③	T6/T5 ③	T4	T4	T85°C/T100°C ③
		55 (131)	T4	T4	T5 ③	T5 ③	T4	T4	T100°C
		65 (149)	T3C	T3	T5 ③	T5 ③	T4	T3	T100°C
AMLHL3	915	40 (104)	T3C	T3	T6/T5 ③	T6/T5 ③	T3C	T3	T85°C/T100°C ③
		55 (131)	T3C	T3	T5 ③	T5 ③	T3C	T3	T100°C
		65 (149)	—	—	—	—	—	—	—

LED Luminaires | Floodlight | Hazardous Location | NEC / CEC / ATEX / IECEX

#### NEC/CEC — “T” Numbers Represent the Maximum Internal Temperature or Maximum Surface Temperature ④ ⑤

“T” #	T1	350	325	T2	T2A	T2B	T2C	T2D	T3	T3A	T3B	T3C	T4	T4A	T5	T6
Temp. Range °C (°F)	+351 to +450 (+664 to +842)	+326 to +350 (+619 to +662)	+301 to +325 (+574 to +617)	+281 to +300 (+538 to +572)	+261 to +280 (+502 to +536)	+231 to +260 (+448 to +500)	+216 to +230 (+421 to +446)	+201 to +215 (+394 to +419)	+181 to +200 (+358 to +392)	+166 to +180 (+331 to +356)	+161 to +165 (+322 to +329)	+136 to +160 (+277 to +320)	+121 to +135 (+250 to +275)	+101 to +120 (+214 to +248)	+86 to +100 (+187 to +212)	+85 (+185)

Notes: Supply Wire Temperature for all: +90 °C (+194 °F).

For input voltages of 125-169 Vdc, an ambient temperature exceeding +55 °C (+131 °F) is not permitted.

① Diffused polycarbonate lens option is not certified for these ambient temperature and lumen output combinations. Diffused polycarbonate not available for AMLH high lumen series

② Diffused polycarbonate lens is certified for NEC/CEC only. No face up orientation for installation.

③ T5 is maximum allowed temperature code, and T100°C is maximum allowed temperature, when model number includes 3x3 secondary optic.

④ T numbers represent the maximum internal temperature for Class I, Division 2 and Class I, Zone 2 locations designated by the NEC.

⑤ T numbers represent the maximum surface temperature under a dust blanket for Class II, Division 1 and Class I, Zone 2 as designated by the NEC or Zone 2 (Gas) and 22 (Dust) locations as designated by the IEC.



# Areamaster™ Generation 2 and High Lumen LED Series Luminaires

## Floodlight

### Hazardous Locations

NEC/CEC: Class I, Division 2, Groups A, B, C, D | Class II, Division 1, Groups E, F, G | Class II, Division 2, Groups F, G | Class III | Zone 20, 21 and 22 | Class I, Zone 2 AEx/Ex ec IIC Gc | Zone 21, AEx/Ex tb IIIC Db | Type 3R, 4 and 4X | IP66/67 | Simultaneous Exposure | Marine Outside Type (Salt Water) for USA Only | Wet Locations  
 ATEX/IECEx: Zone 2, 21, 22 | II 2D 3G 3D | IK08 | IP66  
 Markings: CE | UKCA  
 Notable: American Bureau of Shipping (ABS) Certified | 10G Vibration

#### ATEX/IECEx Temperature Codes

Model	Max Driver Current (mA)	Gas — T Rating			Dust — Surface Temperature		
		+40°C (+104°F)	+55°C (+131°F)	+65°C (+149°F)	+40°C (+104°F)	+55°C (+131°F)	+65°C (+149°F)
AMLGL6	410	T5	T4	T4	T85°C	T85°C	T85°C
AMLGL7	680	T4	T3	T3	T85°C	T85°C	T100°C
AMLGL8	930	T3	T3	T3	T85°C	T100°C	T100°C
AMLHL1	530	T4	T4	T3	T85°C ①	T85°C ①	T85°C ①
AMLHL2	680	T4	T4	T3	T85°C ①	T100°C	T100°C
AMLHL3	915	T4	T3	—	T100°C	T100°C	—

#### ATEX/IECEx — “T” Numbers Represent the Maximum Internal Temperature or Maximum Surface Temperature

“T” #	T1	T2	T3	T4	T5	T6
Temp. Range °C (°F)	+301 to +450 (+547 to +842)	+201 to +300 (+394 to +572)	+136 to +200 (+277 to +392)	+101 to +135 (+214 to +275)	+86 to +100 (+187 to +212)	+85 (+185)

① Areamaster High Lumen with 3x3 secondary optic surface temperature is T100°C for these ranges.





# Areamaster™ Generation 2 and High Lumen LED Series Luminaires

## Floodlight

### Hazardous Locations

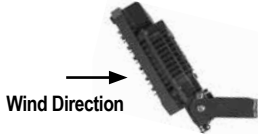
NEC/CEC: Class I, Division 2, Groups A, B, C, D | Class II, Division 1, Groups E, F, G | Class II, Division 2, Groups F, G | Class III | Zone 20, 21 and 22 | Class I, Zone 2 AEx/Ex ec IIC Gc | Zone 21, AEx/Ex tb IIC Db | Type 3R, 4 and 4X | IP66/67 | Simultaneous Exposure | Marine Outside Type (Salt Water) for USA Only | Wet Locations  
 ATEX/IECEX: Zone 2, 21, 22 | II 2D 3G 3D | IK08 | IP66  
 Markings: CE | UKCA  
 Notable: American Bureau of Shipping (ABS) Certified | 10G Vibration

Luminaire Category		Frontal Projected Area (FPA) ft <sup>2</sup>	Drag Coefficient (DC)	Effective Projected Area (EPA) = FPA*DC ft <sup>2</sup>
<b>Low Lumen Model — AMLG</b>				
90° to Ground-Worst Case Mounting		1.52	1.20	1.82
45° to Ground-Standard Mounting		1.07	1.2	1.28
<b>High Lumen Model — AMLH</b>				
90° to Ground-Worst Case Mounting		2.04	1.20	2.45
45° to Ground-Standard Mounting		1.44	1.20	1.73

LED Luminaires | Floodlight | Hazardous Location | NEC / CEC / ATEX / IECEX

# Areaster™ Generation 2 and High Lumen LED Series Luminaires





## Floodlight

### Hazardous Locations

NEC/CEC: Class I, Division 2, Groups A, B, C, D | Class II, Division 1, Groups E, F, G | Class II, Division 2, Groups F, G | Class III | Zone 20, 21 and 22 | Class I, Zone 2 AEx/Ex ec IIC Gc | Zone 21, AEx/Ex tb IIC Db | Type 3R, 4 and 4X | IP66/67 | Simultaneous Exposure | Marine Outside Type (Salt Water) for USA Only | Wet Locations  
 ATEX/IECEX: Zone 2, 21, 22 | II 2D 3G 3D | IK08 | IP66  
 Markings: CE | UKCA  
 Notable: American Bureau of Shipping (ABS) Certified | 10G Vibration



LED Luminaires | Floodlight | Hazardous Location | NEC / CEC / ATEX / IECEX

#### Accessories and Replacement Parts

	Description	Weight in kg (lbs)	Weight in kg (lbs)	Catalog Number
<b>Crossarm Mounting Bracket</b>				
	Has 180° horizontal adjustment — degree marked. Facilitates mounting floodlight to crossarm or other flat surface, or to GAM8WB. Includes floodlight yoke bolts. Malleable iron, zinc plated, chromate sealed, architectural bronze polyester finish.	1.4 (3.1)		<b>GAM8CA</b>
<b>Pipe or Wall Mount Bracket</b>				
	Used with GAM8CA. Clamps to 1" to 2-1/2" pipe, vertical or horizontal, or mounts on flat surfaces. Includes U-bolt and crossarm bracket bolts. Malleable iron, zinc plated, chromate sealed, with architectural bronze polyester finish.	2.9 (6.4)		<b>GAM8WB</b>
	<i>Crossarm Mounting Bracket (GAM8CA) used with Pipe or Wall Mount Bracket (GAM8WB).</i>			
	Slip-fits 1" or 1-1/2" pipe size poletop tenons. Includes floodlight yoke bolts, 3 locking bolts, and cord grip. Body is malleable iron-zinc plated, chromate sealed, with cast aluminum cap. Assembly has architectural bronze polyester finish.	2.4 (5.3)		<b>AMLEDSF1</b>
	Slip-fits 2" or 2-1/2" poletop tenons. Includes floodlight yoke bolts, 3 locking bolts, and cord grip. Malleable iron, zinc plated, chromate sealed, with architectural bronze polyester finish.	2.8 (6.2)		<b>GAM8SF</b>



#### Photocontrol Kit — Separate FS Cast Hub Device Box (Step 1) and Photocontrol in FS Cover (Step 2)







	Voltage Range	Max VA	Max VA	Max Current Amps	Photocell Catalog Number	Device Box Catalog Number	
						Iron	Aluminum
<b>Step 1: FS Cast Hub Device Box — single gang 2.00 in. deep FS Box, with one 3/4 in. bottom hub entry — Order separately</b> — Connect FS Box to luminaire wiring compartment with 3/4 in. close conduit nipple or 3/4 in. 90° elbow. Purchased separately from other supplier.							
	N/A	N/A	N/A	N/A	—	<b>APP-FS-1-75</b>	<b>APP-FS-1-75-A</b>
<b>Step 2: Photocontrol in FS Cover for installation in FS Cast Hub Device Box — Order separately</b> — Supplied with two stainless screws and neoprene gasket, catalog number: FS-GKR-1N							
	120 V, 50/60 Hz	1000	1000	8.3 Amp	<b>FSKA-PC120D2</b>	—	—
	208 V, 50/60 Hz	1000	1000	4.8 Amp			
	240 V, 50/60 Hz	1000	1000	4.2 Amp	<b>FSKA-PC247D2</b>	—	—
	277 V, 50/60 Hz	1000	1000	3.6 Amp			

# Areamaster™ Generation 2 and High Lumen LED Series Luminaires

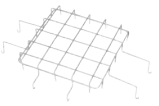
## Floodlight

### Hazardous Locations

NEC/CEC: Class I, Division 2, Groups A, B, C, D | Class II, Division 1, Groups E, F, G | Class II, Division 2, Groups F, G | Class III | Zone 20, 21 and 22 | Class I, Zone 2 AEx/Ex ec IIC Gc | Zone 21, AEx/Ex tb IIC Db | Type 3R, 4 and 4X | IP66/67 | Simultaneous Exposure | Marine Outside Type (Salt Water) for USA Only | Wet Locations  
 ATEX/IECEX: Zone 2, 21, 22 | II 2D 3G 3D | IK08 | IP66  
 Markings: CE | UKCA  
 Notable: American Bureau of Shipping (ABS) Certified | 10G Vibration

Accessories and Replacement Parts			
	Description	Weight in kg (lbs)	Catalog Number
<b>Wall Mount Bracket</b>			
	Used with GAM8SF to provide a wall mounting option. Galvanized Steel.	4.8 (10.5)	<b>GPSWB6GAL</b>
<b>Wire Guard</b>			
	Stainless steel.	0.2 (0.4)	<b>LGGUARD</b> <b>LHGUARD</b>
<b>Safety Cable</b>			
	Stainless steel.	0.2 (0.4)	<b>LEDSC</b>
<b>Visor</b>			
	Steel with architectural bronze polyester finish. For Dark Sky Friendly design.	0.2 (0.4)	<b>AMLGV</b> <b>AMLHV</b>
<b>Portable Floodlight Base</b>			
	Portable floodlight base for temporary lighting applications. To be used with wire guard. Malleable iron with architectural bronze polyester finish.	2.4 (5.2)	<b>GAMPFB</b>
<b>Replacement Covers/Lenses</b>			
	Clear Glass — AMLGL6, AMLGL7, AMLGL8	2.2 (4.8)	<b>AMLGCLEAR</b>
	Frosted Glass — AMLGL6, AMLGL7, AMLGL8	2.0 (4.5)	<b>AMLG Frost</b>
	Diffused Polycarbonate — AMLGL6, AMLGL7, AMLGL8	1.6 (3.5)	<b>AMLGDIFFP</b>
	Clear Glass — AMLHL1, AMLHL2, AMLHL3	2.4 (5.3)	<b>AMLHCLEAR</b>
	Frosted Glass — AMLHL1, AMLHL2, AMLHL3	2.4 (5.3)	<b>AMLHFROST</b>
<b>Yoke Mount Bracket</b>			
	Stainless Steel Yoke Mount Bracket. For installations requiring a higher degree of corrosion protection. Made with all stainless steel components, no painted finish.	1.8 (4.0)	<b>AMLYMSS</b>
	Architectural Bronze Replacement Yoke Bracket	1.41 (3.1)	<b>AMLYMAB</b>
	Architectural Bronze Replacement Yoke Bracket - Matches mounting hole pattern of Crouse-Hinds™ † Champ FMVA and Champ Pro PFMA LED series floodlights	1.41 (3.1)	<b>AMLYMCH</b>

† Crouse-Hinds and Champ are registered trademarks of Eaton.

LED Luminaires | Floodlight | Hazardous Location | NEC / CEC / ATEX / IECEx

# Areamaster™ Generation 2 and High Lumen LED Series Luminaires

## Floodlight

### Hazardous Locations

NEC/CEC: Class I, Division 2, Groups A, B, C, D | Class II, Division 1, Groups E, F, G | Class II, Division 2, Groups F, G | Class III | Zone 20, 21 and 22 | Class I, Zone 2 AEx/Ex ec IIC Gc |



Zone 21, AEx/Ex tb IIC Db | Type 3R, 4 and 4X | IP66/67 | Simultaneous Exposure | Marine Outside Type (Salt Water) for USA Only | Wet Locations

ATEX/IECEX: Zone 2, 21, 22 | II 2D 3G 3D | IK08 | IP66

Markings: CE | UKCA

Notable: American Bureau of Shipping (ABS) Certified | 10G Vibration

### Replacement Drivers

	Model	Voltage	Driver Wattage	Constant Current Setting	Catalog Number
	<b>Low Lumen Model</b>				
	AMLGL6C, AMLGL6N, AMLGL6W	BU	100 Watt	410mA	APMS100C105UD41
		BH			APMS100C105HD41
	AMLGL7W	BU	150 Watt	650mA	APMS150C105UD65
		BH			APMS150C105HD65
	AMLGL7C, AMLGL7N	BU	150 Watt	680mA	APMS150C105UD68
		BH			APMS150C105HD68
	AMLGL8W	BU	150 Watt	890mA	APMS150C105UD89
		BH			APMS150C105HD89
	AMLGL8C, AMLGL8N	BU	150 Watt	930mA	APMS150C105UD93
BH		APMS150C105HD93			
	<b>High Lumen Model</b>				
	AMLHL1C, AMLHL1N, AMLHL1W	BU	100 Watt	530mA	APMS100C105UD53
		BH			APMS100C105HD53
	AMLHL2W	BU	150 Watt	650mA	APMS150C105UD65
		BH			APMS150C105HD65
	AMLHL2C, AMLHL2N	BU	150 Watt	680mA	APMS150C105UD68
		BH			APMS150C105HD68
	AMLHL3W	BU	150 Watt	890mA	APMS150C105UD89
		BH			APMS150C105HD89
	AMLHL3C, AMLHL3N	BU	150 Watt	915mA	APMS150C105UD91
BH		APMS150C105HD91			

### Luminaire Weights

Description	Weight in kg (lbs)
Low Lumen Model — AMLGL6, AMLGL7, AMLGL8 Luminaires	9.8 (21.6)
High Lumen Model — AMLHL1, AMLHL2, AMLHL3 Luminaires	16.1 (35.4)

# Areamaster™ Generation 2 and High Lumen LED Series Luminaires

## Floodlight

### Hazardous Locations

NEC/CEC: Class I, Division 2, Groups A, B, C, D | Class II, Division 1, Groups E, F, G | Class II, Division 2, Groups F, G | Class III | Zone 20, 21 and 22 | Class I, Zone 2 AEx/Ex ec IIC Gc | Zone 21, AEx/Ex tb IIIC Db | Type 3R, 4 and 4X | IP66/67 | Simultaneous Exposure | Marine Outside Type (Salt Water) for USA Only | Wet Locations  
 ATEX/IECEX: Zone 2, 21, 22 | II 2D 3G 3D | IK08 | IP66  
 Markings: CE | UKCA  
 Notable: American Bureau of Shipping (ABS) Certified | 10G Vibration

### AMLG Dimensions in Millimeters (Inches) — Floodlight — Low Lumen Model

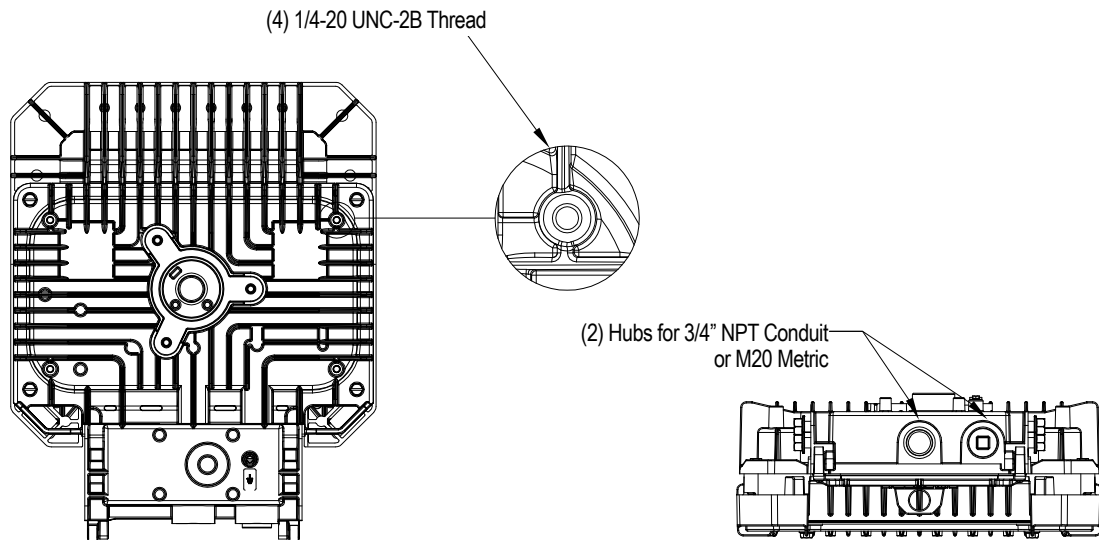
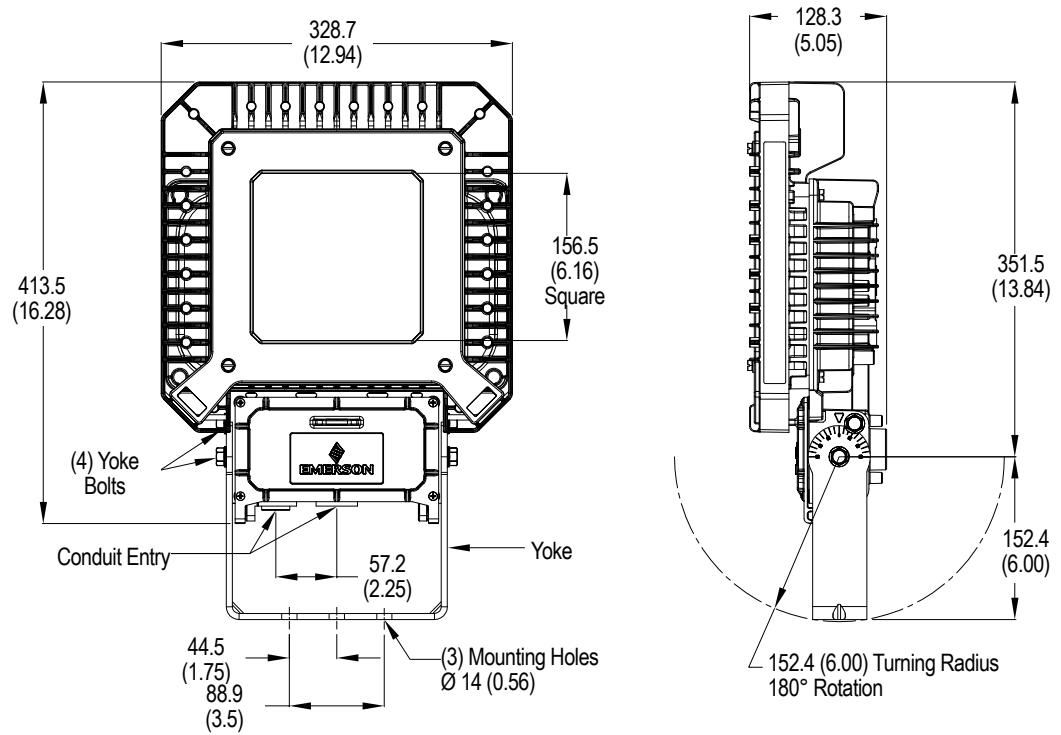

LED Luminaires | Floodlight | Hazardous Location | NEC / CEC / ATEX / IECEx

# Areaster™ Generation 2 and High Lumen LED Series Luminaires

## Floodlight

### Hazardous Locations

NEC/CEC: Class I, Division 2, Groups A, B, C, D | Class II, Division 1, Groups E, F, G | Class II, Division 2, Groups F, G | Class III | Zone 20, 21 and 22 | Class I, Zone 2 AEx/Ex ec IIC Gc | Zone 21, AEx/Ex tb IIC Db | Type 3R, 4 and 4X | IP66/67 | Simultaneous Exposure | Marine Outside Type (Salt Water) for USA Only | Wet Locations  
 ATEX/IECEX: Zone 2, 21, 22 | II 2D 3G 3D | IK08 | IP66  
 Markings: CE | UKCA  
 Notable: American Bureau of Shipping (ABS) Certified | 10G Vibration

#### AMLH Dimensions in Millimeters (Inches) — Floodlight — High Lumen Model

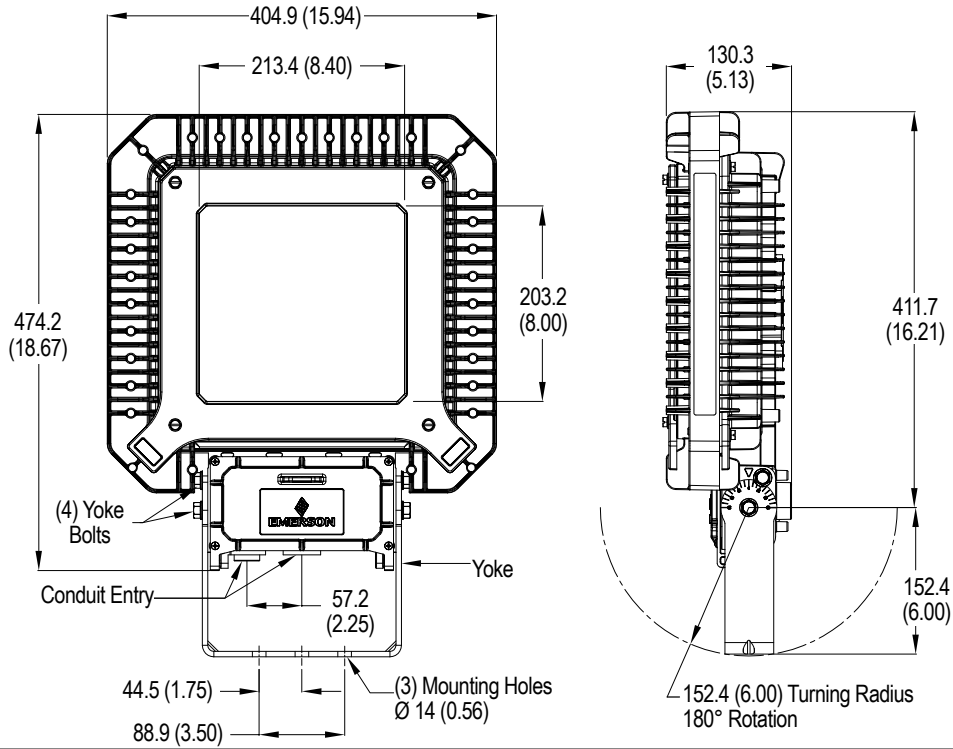

(4) 1/4-20 UNC-2B Thread

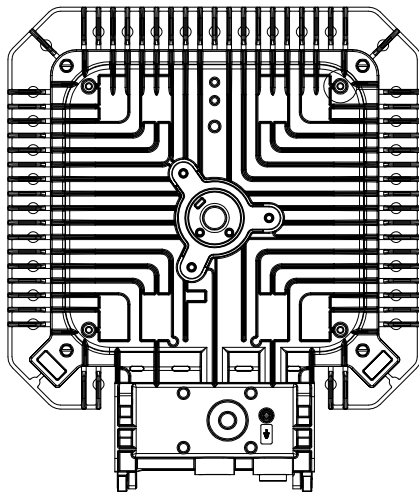

(2) Hubs for 3/4" NPT Conduit or M20 Metric

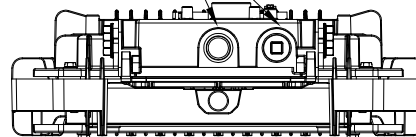

# Areaster™ Generation 2 and High Lumen LED Series Luminaires

## Floodlight

### Hazardous Locations

NEC/CEC: Class I, Division 2, Groups A, B, C, D | Class II, Division 1, Groups E, F, G | Class II, Division 2, Groups F, G | Class III | Zone 20, 21 and 22 | Class I, Zone 2 AEx/Ex ec IIC Gc | Zone 21, AEx/Ex tb IIC Db | Type 3R, 4 and 4X | IP66/67 | Simultaneous Exposure | Marine Outside Type (Salt Water) for USA Only | Wet Locations  
 ATEX/IECEX: Zone 2, 21, 22 | II 2D 3G 3D | IK08 | IP66  
 Markings: CE | UKCA  
 Notable: American Bureau of Shipping (ABS) Certified | 10G Vibration

### Photometric Data — DATA SHOWN IS ABSOLUTE

NEMA 7x7, Clear Glass, 5000K CCT

REPORT NUMBER: AMLGL6CG6BU

Luminaire Lumens 9,964

#### POLAR CANDELA DISTRIBUTION

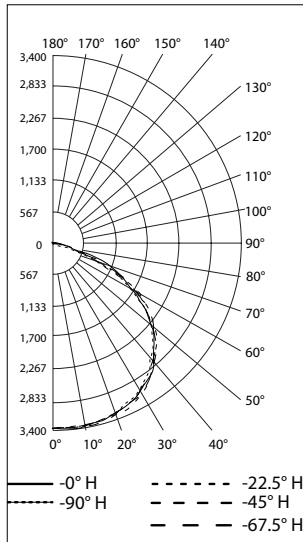

#### ISOLUX PLOT AT 45°

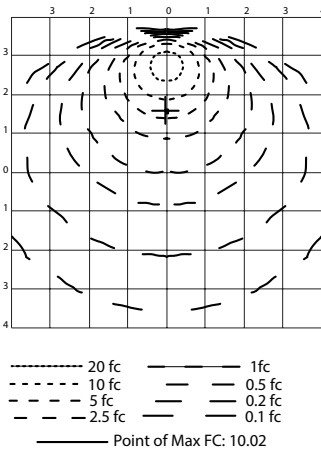

#### FLOOD SUMMARY

	Efficiency	Lumens	Horizontal Spread	Vertical Spread
Field (10%)	98.5%	9,817.4	150	148
Beam (50%)	82.2%	8,196.6	117.3	116.2
Total	100%	9,964.0		

#### Tilt Angle- 45 Degree LLF-0.9

Mounting Height m (ft)	Maximum Point (fc)	Forward Throw Distance			
		0.5fc/5lx m (ft)	1fc/11lx m (ft)	2fc/22lx m (ft)	5fc/54lx m (ft)
6 (20)	1.51	14 (45)	11 (35)	7 (24)	3 (11)
9 (30)	0.68	14 (47)	11 (36)	6 (21)	—
12 (40)	0.38	15 (50)	11 (35)	—	—

Mounting Height m (ft)	Side-to-Side Distance			
	0.5fc/5lx m (ft)	1fc/11lx m (ft)	2fc/22lx m (ft)	5fc/54lx m (ft)
6 (20)	20 (66)	15 (50)	12 (38)	5 (16)
9 (30)	24 (78)	15 (50)	9 (28)	—
12 (40)	21 (70)	12 (40)	—	—

NEMA 7x7, Frosted Glass, 5000K CCT

REPORT NUMBER: AMLGL6CF6BU

Luminaire Lumens 8,115

#### POLAR CANDELA DISTRIBUTION

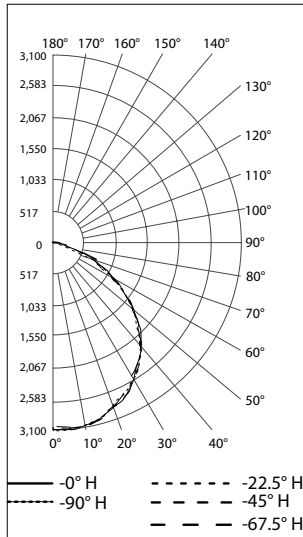

#### ISOLUX PLOT AT 45°

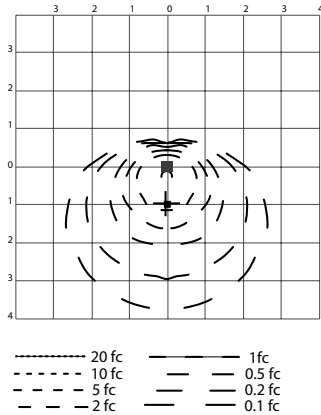

#### FLOOD SUMMARY

	Efficiency	Lumens	Horizontal Spread	Vertical Spread
Field (10%)	98.1%	7,961.7	155.3	151.5
Beam (50%)	71.5%	5,804.1	105.8	105.5
Total	100%	8,112.2		

#### Tilt Angle- 45 Degree LLF-0.9

Mounting Height m (ft)	Maximum Point (fc)	Forward Throw Distance			
		0.5fc/5lx m (ft)	1fc/11lx m (ft)	2fc/22lx m (ft)	5fc/54lx m (ft)
6 (20)	2.49	13 (42)	10 (33)	7 (24)	2 (8)
9 (30)	1.1	14 (45)	10 (32)	5 (15)	—
12 (40)	0.62	15 (48)	8 (25)	—	—

Mounting Height m (ft)	Side-to-Side Distance			
	0.5fc/5lx m (ft)	1fc/11lx m (ft)	2fc/22lx m (ft)	5fc/54lx m (ft)
6 (20)	18 (60)	13 (44)	9 (30)	1 (4)
9 (30)	20 (64)	10 (34)	6 (20)	—
12 (40)	17 (56)	9 (30)	—	—



# Areamaster™ Generation 2 and High Lumen LED Series Luminaires

## Floodlight

### Hazardous Locations

NEC/CEC: Class I, Division 2, Groups A, B, C, D | Class II, Division 1, Groups E, F, G | Class II, Division 2, Groups F, G | Class III | Zone 20, 21 and 22 | Class I, Zone 2 AEx/Ex ec IIC Gc | Zone 21, AEx/Ex tb IIIC Db | Type 3R, 4 and 4X | IP66/67 | Simultaneous Exposure | Marine Outside Type (Salt Water) for USA Only | Wet Locations  
 ATEX/IECEx: Zone 2, 21, 22 | II 2D 3G 3D | IK08 | IP66  
 Markings: CE | UKCA  
 Notable: American Bureau of Shipping (ABS) Certified | 10G Vibration

### Photometric Data — DATA SHOWN IS ABSOLUTE

NEMA 7x7, Clear Glass, 5000K CCT

REPORT NUMBER: AMLGL7CG6BU

Luminaire Lumens 15,320

#### POLAR CANDELA DISTRIBUTION

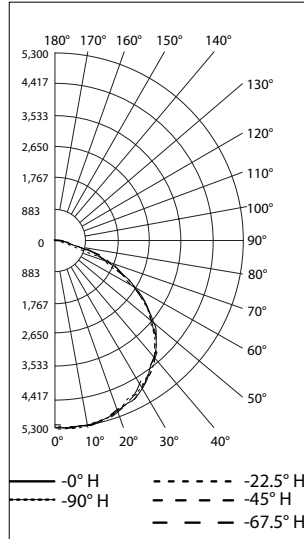

#### ISOLUX PLOT AT 45°

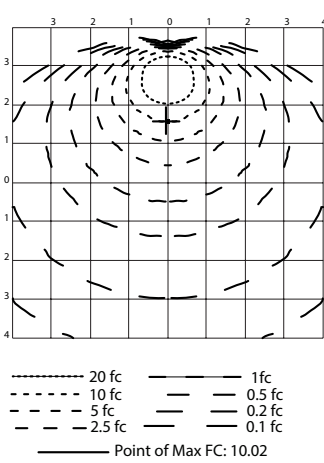

#### FLOOD SUMMARY

	Efficiency	Lumens	Horizontal Spread	Vertical Spread
Field (10%)	98.5%	15,102.6	151.2	147
Beam (50%)	81.9%	12,555.7	117	115.4
Total	100%	15,320.4		

Tilt Angle- 45 Degree LLF-0.9

Mounting Height m (ft)	Maximum Point (fc)	Forward Throw Distance			
		0.5fc/5lx m (ft)	1fc/11lx m (ft)	2fc/22lx m (ft)	5fc/54lx m (ft)
6 (20)	4.42	15 (50)	12 (39)	9 (29)	5 (16)
9 (30)	1.97	17 (55)	13 (43)	8 (25)	—
12 (40)	1.11	17 (57)	12 (40)	6 (19)	—

Mounting Height m (ft)	Side-to-Side Distance			
	0.5fc/5lx m (ft)	1fc/11lx m (ft)	2fc/22lx m (ft)	5fc/54lx m (ft)
6 (20)	21 (70)	56 (17)	12 (40)	6 (20)
9 (30)	24 (80)	58 (18)	12 (38)	—
12 (40)	24 (80)	50 (15)	5 (16)	—

NEMA 7x7, Frosted Glass, 5000K CCT

REPORT NUMBER: AMLGL7CF6BU

Luminaire Lumens 12,782

#### POLAR CANDELA DISTRIBUTION

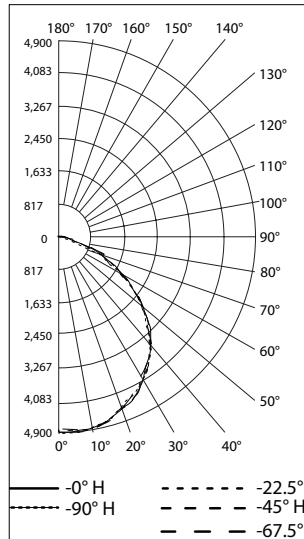

#### ISOLUX PLOT AT 45°

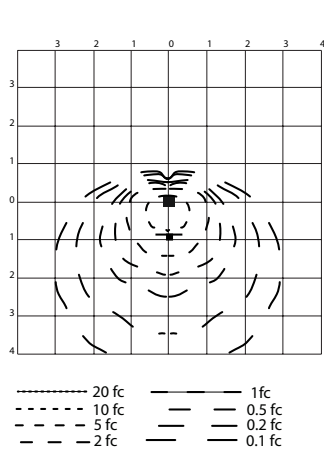

#### FLOOD SUMMARY

	Efficiency	Lumens	Horizontal Spread	Vertical Spread
Field (10%)	98.1%	12,536.1	155.4	150.7
Beam (50%)	71.3%	9,112.8	105.4	105.6
Total	100%	12,777.9		

Tilt Angle- 45 Degree LLF-0.9

Mounting Height m (ft)	Maximum Point (fc)	Forward Throw Distance			
		0.5fc/5lx m (ft)	1fc/11lx m (ft)	2fc/22lx m (ft)	5fc/54lx m (ft)
6 (20)	2.91	18 (59)	14 (45)	11 (35)	7 (22)
9 (30)	1.29	19 (63)	16 (51)	10 (33)	4 (12)
12 (40)	0.73	21 (70)	15 (50)	9 (30)	—

Mounting Height m (ft)	Side-to-Side Distance			
	0.5fc/5lx m (ft)	1fc/11lx m (ft)	2fc/22lx m (ft)	5fc/54lx m (ft)
6 (20)	26 (84)	21 (70)	16 (52)	10 (32)
9 (30)	29 (96)	22 (72)	16 (54)	5 (15)
12 (40)	32 (104)	22 (72)	15 (48)	—

LED Luminaires | Floodlight | Hazardous Location | NEC / CEC / ATEX / IECEx

# Areamaster™ Generation 2 and High Lumen LED Series Luminaires

## Floodlight

### Hazardous Locations

NEC/CEC: Class I, Division 2, Groups A, B, C, D | Class II, Division 1, Groups E, F, G | Class II, Division 2, Groups F, G | Class III | Zone 20, 21 and 22 | Class I, Zone 2 AEx/Ex ec IIC Gc | Zone 21, AEx/Ex tb IIC Db | Type 3R, 4 and 4X | IP66/67 | Simultaneous Exposure | Marine Outside Type (Salt Water) for USA Only | Wet Locations  
 ATEX/IECEX: Zone 2, 21, 22 | II 2D 3G 3D | IK08 | IP66  
 Markings: CE | UKCA  
 Notable: American Bureau of Shipping (ABS) Certified | 10G Vibration

### Photometric Data — DATA SHOWN IS ABSOLUTE

NEMA 7x7, Clear Glass, 5000K CCT

REPORT NUMBER: AMLGL8CG6BU

Luminaire Lumens 19,895

#### POLAR CANDELA DISTRIBUTION

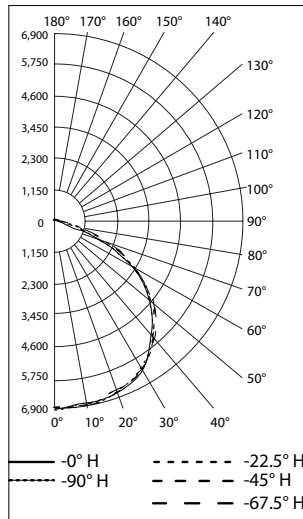

#### ISOLUX PLOT AT 45°

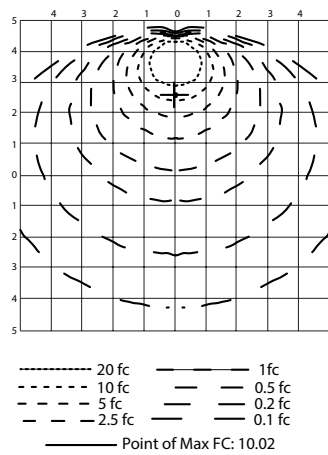

#### FLOOD SUMMARY

	Efficiency	Lumens	Horizontal Spread	Vertical Spread
Field (10%)	98.6%	19,614.8	151	146.8
Beam (50%)	81.7%	16,267.6	116.7	115.2
Total	100%	19,895.4		

#### Tilt Angle- 45 Degree LLF-0.9

Mounting Height m (ft)	Maximum Point (fc)	Forward Throw Distance			
		0.5fc/5lx m (ft)	1fc/11lx m (ft)	2fc/22lx m (ft)	5fc/54lx m (ft)
6 (20)	3.18	13 (44)	11 (36)	9 (30)	5 (16)
9 (30)	1.41	16 (53)	13 (42)	8 (27)	—
12 (40)	0.81	17 (56)	12 (40)	—	—

Mounting Height m (ft)	Side-to-Side Distance			
	0.5fc/5lx m (ft)	1fc/11lx m (ft)	2fc/22lx m (ft)	5fc/54lx m (ft)
6 (20)	26 (84)	20 (64)	13 (44)	5 (16)
9 (30)	27 (90)	20 (66)	11 (36)	—
12 (40)	29 (96)	17 (56)	—	—

### NEMA 7x7, Frosted Glass, 5000K CCT

REPORT NUMBER: AMLGL8CF6BU

Luminaire Lumens 16,503

#### POLAR CANDELA DISTRIBUTION

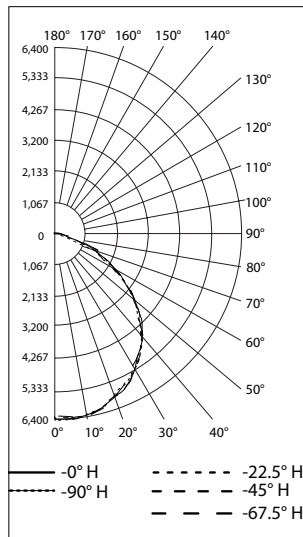

#### ISOLUX PLOT AT 45°

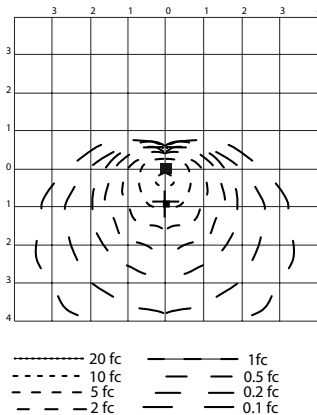

#### FLOOD SUMMARY

	Efficiency	Lumens	Horizontal Spread	Vertical Spread
Field (10%)	98.1%	16,189.8	155.3	150.7
Beam (50%)	71.3%	11,766.7	105.2	105.5
Total	100%	16,498.6		

#### Tilt Angle- 45 Degree LLF-0.9

Mounting Height m (ft)	Maximum Point (fc)	Forward Throw Distance			
		0.5fc/5lx m (ft)	1fc/11lx m (ft)	2fc/22lx m (ft)	5fc/54lx m (ft)
6 (20)	5.76	17 (55)	11 (36)	10 (32)	6 (20)
9 (30)	2.56	16 (53)	9 (31)	9 (31)	—
12 (40)	1.43	17 (56)	19 (62)	9 (29)	—

Mounting Height m (ft)	Side-to-Side Distance			
	0.5fc/5lx m (ft)	1fc/11lx m (ft)	2fc/22lx m (ft)	5fc/54lx m (ft)
6 (20)	24 (78)	18 (60)	13 (44)	7 (22)
9 (30)	27 (88)	19 (62)	10 (34)	—
12 (40)	30 (98)	18 (58)	12 (38)	—

LED Luminaires | Floodlight | Hazardous Location | NEC / CEC / ATEX / IECEx

# Areaster™ Generation 2 and High Lumen LED Series Luminaires

## Floodlight

### Hazardous Locations

NEC/CEC: Class I, Division 2, Groups A, B, C, D | Class II, Division 1, Groups E, F, G | Class II, Division 2, Groups F, G | Class III | Zone 20, 21 and 22 | Class I, Zone 2 AEx/Ex ec IIC Gc | Zone 21, AEx/Ex tb IIC Db | Type 3R, 4 and 4X | IP66/67 | Simultaneous Exposure | Marine Outside Type (Salt Water) for USA Only | Wet Locations  
 ATEX/IECEx: Zone 2, 21, 22 | II 2D 3G 3D | IK08 | IP66  
 Markings: CE | UKCA  
 Notable: American Bureau of Shipping (ABS) Certified | 10G Vibration

### Photometric Data — DATA SHOWN IS ABSOLUTE

NEMA 7x6, Clear Glass, 5000K CCT

REPORT NUMBER: AMLGL6CG7BU

Luminaire Lumens 9,086

#### POLAR CANDELA DISTRIBUTION

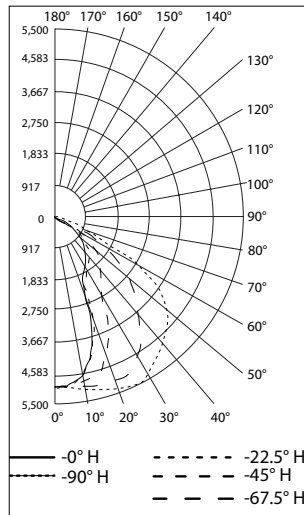

#### ISOLUX PLOT AT 45°

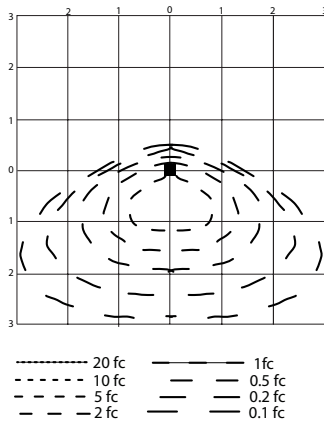

#### FLOOD SUMMARY

	Efficiency	Lumens	Horizontal Spread	Vertical Spread
Field (10%)	96.2%	8,738.1	134.9	112.1
Beam (50%)	62%	5,631.5	120.5	45.2
Total	100%	9,086.2		

Tilt Angle- 45 Degree LLF-0.9

Mounting Height m (ft)	Maximum Point (fc)	Forward Throw Distance			
		0.5fc/5lx m (ft)	1fc/11lx m (ft)	2fc/22lx m (ft)	5fc/54lx m (ft)
6 (20)	2.92	13 (42)	11 (36)	9 (28)	5 (15)
9 (30)	1.3	16 (53)	13 (42)	7 (24)	—
12 (40)	0.73	17 (56)	11 (36)	—	—

Mounting Height m (ft)	Side-to-Side Distance			
	0.5fc/5lx m (ft)	1fc/11lx m (ft)	2fc/22lx m (ft)	5fc/54lx m (ft)
6 (20)	24 (80)	20 (64)	13 (44)	5 (16)
9 (30)	26 (84)	18 (60)	11 (36)	—
12 (40)	27 (88)	15 (48)	—	—

NEMA 7x6, Clear Glass, 3000K CCT

REPORT NUMBER: AMLGL6WG7BU

Luminaire Lumens 8,111

#### POLAR CANDELA DISTRIBUTION

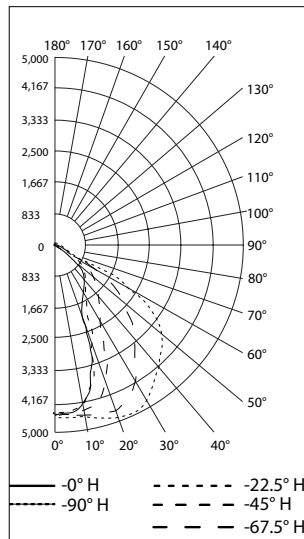

#### ISOLUX PLOT AT 45°

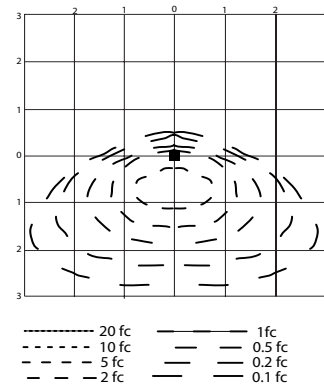

#### FLOOD SUMMARY

	Efficiency	Lumens	Horizontal Spread	Vertical Spread
Field (10%)	96.1%	7,798.3	135.3	112
Beam (50%)	61.5%	4,987.0	119.9	45
Total	100%	8,111.0		

Tilt Angle- 45 Degree LLF-0.9

Mounting Height m (ft)	Maximum Point (fc)	Forward Throw Distance			
		0.5fc/5lx m (ft)	1fc/11lx m (ft)	2fc/22lx m (ft)	5fc/54lx m (ft)
6 (20)	2.92	13 (42)	11 (36)	9 (28)	5 (15)
9 (30)	1.30	16 (53)	13 (42)	7 (24)	—
12 (40)	0.73	17 (56)	11 (36)	—	—

Mounting Height m (ft)	Side-to-Side Distance			
	0.5fc/5lx m (ft)	1fc/11lx m (ft)	2fc/22lx m (ft)	5fc/54lx m (ft)
6 (20)	24 (80)	20 (64)	13 (44)	5 (16)
9 (30)	26 (84)	18 (60)	11 (36)	—
12 (40)	27 (88)	15 (48)	—	—

LED Luminaires | Floodlight | Hazardous Location | NEC / CEC / ATEX / IECEx

# Areamaster™ Generation 2 and High Lumen LED Series Luminaires

## Floodlight

### Hazardous Locations

NEC/CEC: Class I, Division 2, Groups A, B, C, D | Class II, Division 1, Groups E, F, G | Class II, Division 2, Groups F, G | Class III | Zone 20, 21 and 22 | Class I, Zone 2 AEx/Ex ec IIC Gc | Zone 21, AEx/Ex tb IIC Db | Type 3R, 4 and 4X | IP66/67 | Simultaneous Exposure | Marine Outside Type (Salt Water) for USA Only | Wet Locations  
 ATEX/IECEX: Zone 2, 21, 22 | II 2D 3G 3D | IK08 | IP66  
 Markings: CE | UKCA  
 Notable: American Bureau of Shipping (ABS) Certified | 10G Vibration

### Photometric Data — DATA SHOWN IS ABSOLUTE

NEMA 7x6, Clear Glass, 5000K CCT

REPORT NUMBER: AMLGL7CG7BU

Luminaire Lumens 14,205

#### POLAR CANDELA DISTRIBUTION

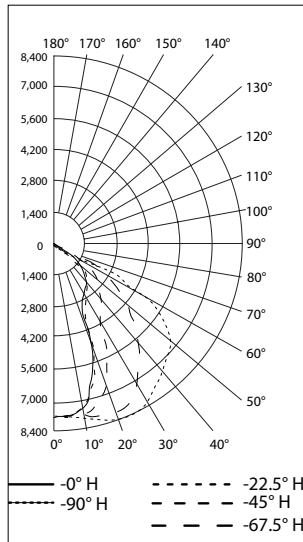

#### ISOLUX PLOT AT 45°

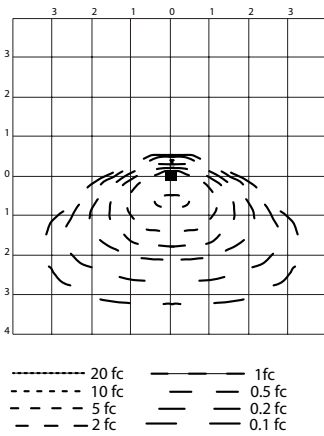

#### FLOOD SUMMARY

	Efficiency	Lumens	Horizontal Spread	Vertical Spread
Field (10%)	96.3%	13,678.5	135.3	112.5
Beam (50%)	62.6%	8,887.6	120.7	45.7
Total	100%	14,205.3		

#### Tilt Angle- 45 Degree LLF-0.9

Mounting Height m (ft)	Maximum Point (fc)	Forward Throw Distance			
		0.5fc/5lx m (ft)	1fc/11lx m (ft)	2fc/22lx m (ft)	5fc/54lx m (ft)
6 (20)	4.91	15 (48)	12 (40)	11 (35)	7 (25)
9 (30)	2.22	18 (60)	14 (45)	12 (38)	—
12 (40)	1.25	20 (64)	16 (52)	—	—

Mounting Height m (ft)	Side-to-Side Distance			
	0.5fc/5lx m (ft)	1fc/11lx m (ft)	2fc/22lx m (ft)	5fc/54lx m (ft)
6 (20)	29 (96)	24 (80)	18 (60)	11 (36)
9 (30)	33 (108)	27 (90)	16 (54)	—
12 (40)	37 (120)	24 (80)	—	—

NEMA 7x6, Clear Glass, 3000K CCT

REPORT NUMBER: AMLGL7WG7BU

Luminaire Lumens 11,971

#### POLAR CANDELA DISTRIBUTION

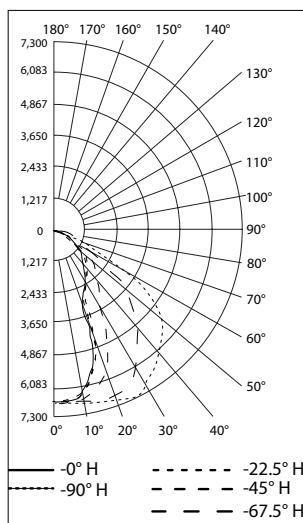

#### ISOLUX PLOT AT 45°

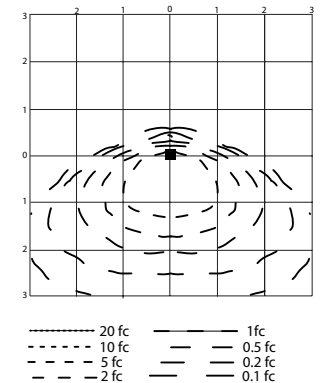

#### FLOOD SUMMARY

	Efficiency	Lumens	Horizontal Spread	Vertical Spread
Field (10%)	96.1%	11,503.9	135.2	112
Beam (50%)	62%	7,424.4	119.8	45.2
Total	100%	11,971.9		

#### Tilt Angle- 45 Degree LLF-0.9

Mounting Height m (ft)	Maximum Point (fc)	Forward Throw Distance			
		0.5fc/5lx m (ft)	1fc/11lx m (ft)	2fc/22lx m (ft)	5fc/54lx m (ft)
6 (20)	4.30	14 (46)	12 (40)	10 (32)	6 (20)
9 (30)	1.91	17 (54)	14 (45)	33 (10)	—
12 (40)	1.07	20 (64)	15 (50)	—	—

Mounting Height m (ft)	Side-to-Side Distance			
	0.5fc/5lx m (ft)	1fc/11lx m (ft)	2fc/22lx m (ft)	5fc/54lx m (ft)
6 (20)	27 (90)	22 (72)	16 (52)	9 (30)
9 (30)	33 (108)	24 (78)	15 (48)	—
12 (40)	34 (112)	22 (72)	—	—

LED Luminaires | Floodlight | Hazardous Location | NEC / CEC / ATEX / IECEx

# Areaster™ Generation 2 and High Lumen LED Series Luminaires

## Floodlight

### Hazardous Locations

NEC/CEC: Class I, Division 2, Groups A, B, C, D | Class II, Division 1, Groups E, F, G | Class II, Division 2, Groups F, G | Class III | Zone 20, 21 and 22 | Class I, Zone 2 AEx/Ex ec IIC Gc | Zone 21, AEx/Ex tb IIC Db | Type 3R, 4 and 4X | IP66/67 | Simultaneous Exposure | Marine Outside Type (Salt Water) for USA Only | Wet Locations  
 ATEX/IECEx: Zone 2, 21, 22 | II 2D 3G 3D | IK08 | IP66  
 Markings: CE | UKCA  
 Notable: American Bureau of Shipping (ABS) Certified | 10G Vibration

### Photometric Data — DATA SHOWN IS ABSOLUTE

NEMA 7x6, Clear Glass, 5000K CCT

REPORT NUMBER: AMLGL8CG7BU

Luminaire Lumens 18,467

#### POLAR CANDELA DISTRIBUTION

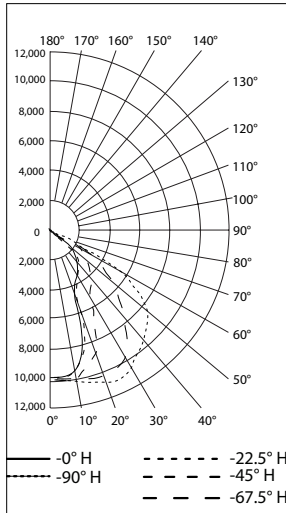

#### ISOLUX PLOT AT 45°

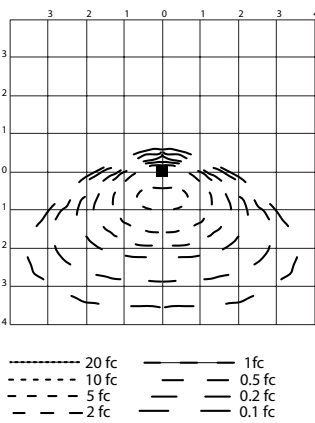

#### FLOOD SUMMARY

	Efficiency	Lumens	Horizontal Spread	Vertical Spread
Field (10%)	96.2%	17,761.1	135.1	112.2
Beam (50%)	62.5%	11,537.1	120.5	45.3
Total	100%	18,467.4		

Tilt Angle- 45 Degree LLF-0.9

Mounting Height m (ft)	Maximum Point (fc)	Forward Throw Distance			
		0.5fc/5lx m (ft)	1fc/11lx m (ft)	2fc/22lx m (ft)	5fc/54lx m (ft)
6 (20)	6.44	16 (52)	13 (44)	11 (36)	8 (26)
9 (30)	2.86	19 (63)	16 (54)	12 (39)	6 (21)
12 (40)	1.63	22 (72)	18 (60)	12 (40)	—

Mounting Height m (ft)	Side-to-Side Distance			
	0.5fc/5lx m (ft)	1fc/11lx m (ft)	2fc/22lx m (ft)	5fc/54lx m (ft)
6 (20)	32 (104)	26 (84)	21 (68)	12 (40)
9 (30)	37 (120)	31 (102)	20 (66)	4 (12)
12 (40)	39 (128)	29 (96)	15 (48)	—

NEMA 7x6, Clear Glass, 3000K CCT

REPORT NUMBER: AMLGL8WG7BU

Luminaire Lumens 15,556

#### POLAR CANDELA DISTRIBUTION

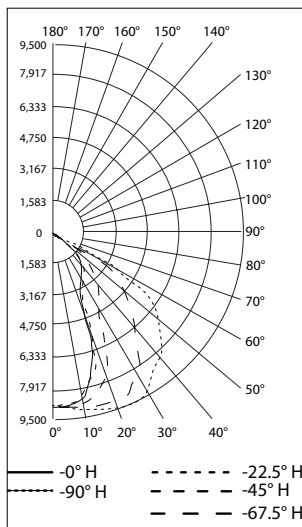

#### ISOLUX PLOT AT 45°

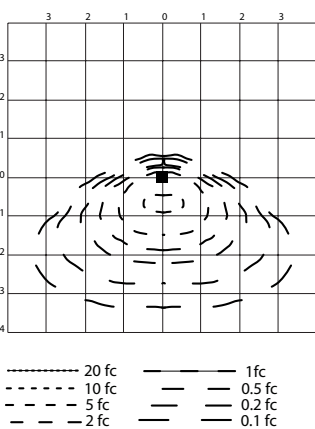

#### FLOOD SUMMARY

	Efficiency	Lumens	Horizontal Spread	Vertical Spread
Field (10%)	96.1%	14,945.7	135	111.8
Beam (50%)	62%	9,641.5	119.5	45
Total	100%	15,555.8		

Tilt Angle- 45 Degree LLF-0.9

Mounting Height m (ft)	Maximum Point (fc)	Forward Throw Distance			
		0.5fc/5lx m (ft)	1fc/11lx m (ft)	2fc/22lx m (ft)	5fc/54lx m (ft)
6 (20)	5.61	15 (50)	13 (42)	11 (36)	8 (26)
9 (30)	2.50	18 (60)	16 (53)	12 (38)	—
12 (40)	1.40	21 (70)	17 (56)	11 (36)	—

Mounting Height m (ft)	Side-to-Side Distance			
	0.5fc/5lx m (ft)	1fc/11lx m (ft)	2fc/22lx m (ft)	5fc/54lx m (ft)
6 (20)	30 (100)	24 (80)	20 (64)	11 (36)
9 (30)	36 (117)	27 (90)	18 (60)	—
12 (40)	37 (120)	24 (80)	12 (40)	—

LED Luminaires | Floodlight | Hazardous Location | NEC / CEC / ATEX / IECEx

# Areaster™ Generation 2 and High Lumen LED Series Luminaires

## Floodlight

### Hazardous Locations

NEC/CEC: Class I, Division 2, Groups A, B, C, D | Class II, Division 1, Groups E, F, G | Class II, Division 2, Groups F, G | Class III | Zone 20, 21 and 22 | Class I, Zone 2 AEx/Ex ec IIC Gc | Zone 21, AEx/Ex tb IIC Db | Type 3R, 4 and 4X | IP66/67 | Simultaneous Exposure | Marine Outside Type (Salt Water) for USA Only | Wet Locations  
 ATEX/IECEX: Zone 2, 21, 22 | II 2D 3G 3D | IK08 | IP66  
 Markings: CE | UKCA  
 Notable: American Bureau of Shipping (ABS) Certified | 10G Vibration

### Photometric Data — DATA SHOWN IS ABSOLUTE

NEMA 5x5, Clear Glass, 5000K CCT

REPORT NUMBER: AMLHL1CG5BU

Luminaire Lumens 24,140

#### POLAR CANDELA DISTRIBUTION

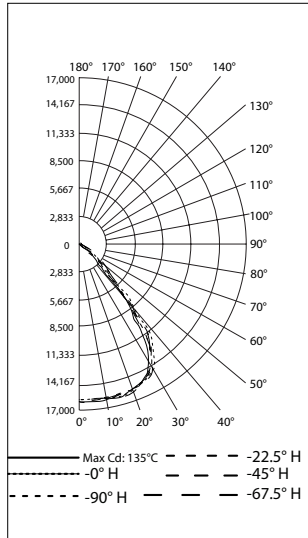

#### ISOLUX PLOT AT 45°

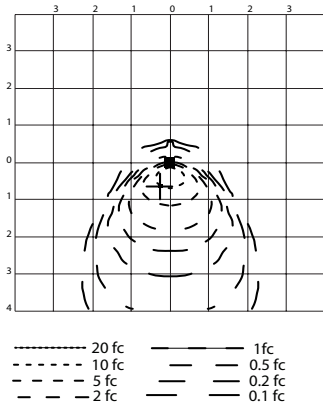

#### FLOOD SUMMARY

	Efficiency	Lumens	Horizontal Spread	Vertical Spread
Field (10%)	94.8%	22,874.5	91.7	91.3
Beam (50%)	84%	20,284.1	75.4	75.9
Total	100%	24,137.4		

Tilt Angle- 45 Degree LLF-0.9

Mounting Height m (ft)	Maximum Point (fc)	Forward Throw Distance			
		0.5fc/5lx m (ft)	1fc/11lx m (ft)	2fc/22lx m (ft)	5fc/54lx m (ft)
9 (30)	8.96	27 (90)	21 (68)	16 (54)	10 (33)
12 (40)	5.04	29 (96)	22 (72)	16 (52)	9 (28)
15 (50)	3.19	30 (100)	23 (75)	15 (50)	—
18 (60)	2.22	32 (105)	24 (78)	14 (45)	—

Mounting Height m (ft)	Side-to-Side Distance			
	0.5fc/5lx m (ft)	1fc/11lx m (ft)	2fc/22lx m (ft)	5fc/54lx m (ft)
9 (30)	29 (96)	24 (78)	19 (63)	14 (45)
12 (40)	32 (104)	27 (88)	20 (64)	10 (32)
15 (50)	37 (120)	29 (95)	18 (60)	—
18 (60)	40 (132)	29 (96)	15 (48)	—

NEMA 5x5, Clear Glass, 3000K CCT

REPORT NUMBER: AMLHL1WG5BU

Luminaire Lumens 21,416

#### POLAR CANDELA DISTRIBUTION

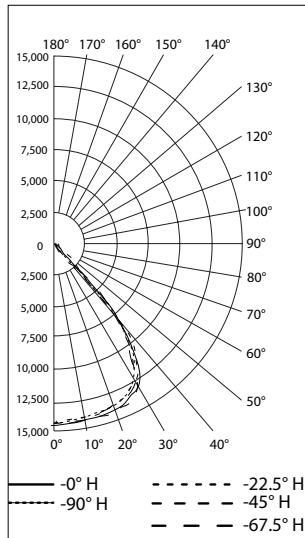

#### ISOLUX PLOT AT 45°

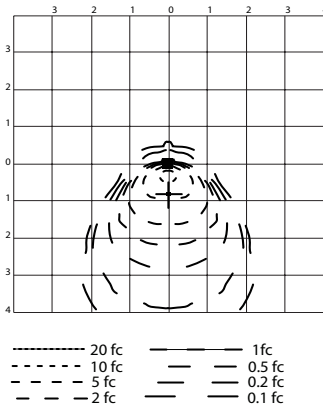

#### FLOOD SUMMARY

	Efficiency	Lumens	Horizontal Spread	Vertical Spread
Field (10%)	95%	20,343.5	95.6	94.3
Beam (50%)	84%	17,982.6	79.7	80.3
Total	100%	21,416.2		

Tilt Angle- 45 Degree LLF-0.9

Mounting Height m (ft)	Maximum Point (fc)	Forward Throw Distance			
		0.5fc/5lx m (ft)	1fc/11lx m (ft)	2fc/22lx m (ft)	5fc/54lx m (ft)
9 (30)	8.96	29 (96)	23 (75)	17 (57)	36 (11)
12 (40)	5.04	32 (104)	24 (80)	18 (60)	10 (32)
15 (50)	3.19	34 (110)	26 (85)	18 (60)	8 (25)
18 (60)	2.22	36 (117)	27 (90)	16 (54)	—

Mounting Height m (ft)	Side-to-Side Distance			
	0.5fc/5lx m (ft)	1fc/11lx m (ft)	2fc/22lx m (ft)	5fc/54lx m (ft)
9 (30)	27 (90)	22 (72)	18 (60)	13 (42)
12 (40)	30 (100)	24 (80)	20 (64)	7 (24)
15 (50)	37 (120)	27 (90)	18 (60)	—
18 (60)	37 (120)	27 (90)	15 (48)	—



# Areamaster™ Generation 2 and High Lumen LED Series Luminaires

## Floodlight

### Hazardous Locations

NEC/CEC: Class I, Division 2, Groups A, B, C, D | Class II, Division 1, Groups E, F, G | Class II, Division 2, Groups F, G | Class III | Zone 20, 21 and 22 | Class I, Zone 2 AEx/Ex ec IIC Gc | Zone 21, AEx/Ex tb IIC Db | Type 3R, 4 and 4X | IP66/67 | Simultaneous Exposure | Marine Outside Type (Salt Water) for USA Only | Wet Locations  
 ATEX/IECEX: Zone 2, 21, 22 | II 2D 3G 3D | IK08 | IP66  
 Markings: CE | UKCA  
 Notable: American Bureau of Shipping (ABS) Certified | 10G Vibration

### Photometric Data — DATA SHOWN IS ABSOLUTE

NEMA 5x5, Clear Glass, 5000K CCT

REPORT NUMBER: AMLHL2CG5BU

Luminaire Lumens 30,068

#### POLAR CANDELA DISTRIBUTION

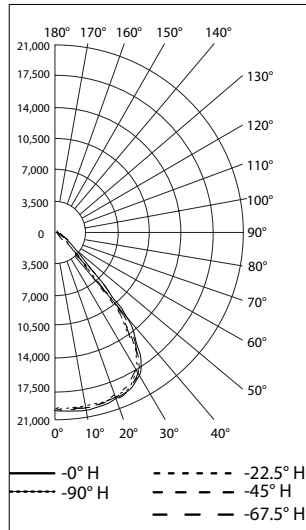

#### ISOLUX PLOT AT 45°

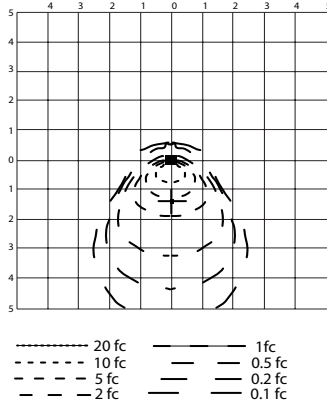

#### FLOOD SUMMARY

	Efficiency	Lumens	Horizontal Spread	Vertical Spread
Field (10%)	94.6%	28,436.7	95.8	93.5
Beam (50%)	83.6%	25,124.4	78.8	79.8
Total	100%	30,069.5		

#### Tilt Angle- 45 Degree LLF-0.9

Mounting Height m (ft)	Maximum Point (fc)	Forward Throw Distance			
		0.5fc/5lx m (ft)	1fc/11lx m (ft)	2fc/22lx m (ft)	5fc/54lx m (ft)
9 (30)	3.84	29 (96)	23 (75)	17 (57)	36 (11)
12 (40)	2.15	32 (104)	24 (80)	18 (60)	10 (32)
15 (50)	1.38	34 (110)	26 (85)	18 (60)	8 (25)
18 (60)	0.97	36 (117)	27 (90)	16 (54)	—

Mounting Height m (ft)	Side-to-Side Distance			
	0.5fc/5lx m (ft)	1fc/11lx m (ft)	2fc/22lx m (ft)	5fc/54lx m (ft)
9 (30)	31 (102)	26 (84)	19 (61)	15 (48)
12 (40)	34 (112)	29 (96)	22 (72)	12 (40)
15 (50)	40 (130)	30 (100)	24 (80)	9 (30)
18 (60)	44 (144)	33 (108)	22 (72)	—

NEMA 5x5, Clear Glass, 3000K CCT

REPORT NUMBER: AMLHL2WG5BU

Luminaire Lumens 25,490

#### POLAR CANDELA DISTRIBUTION

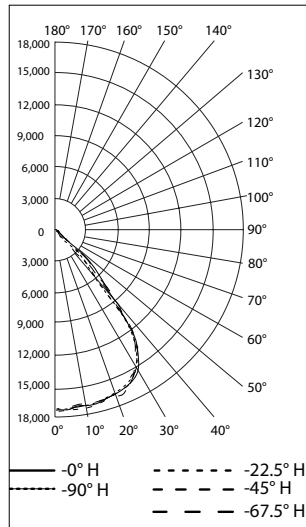

#### ISOLUX PLOT AT 45°

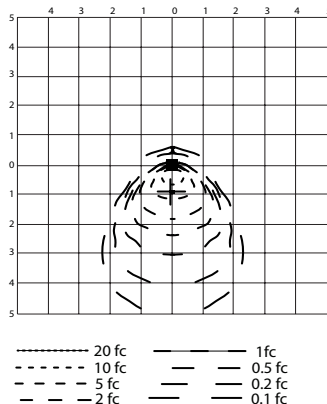

#### FLOOD SUMMARY

	Efficiency	Lumens	Horizontal Spread	Vertical Spread
Field (10%)	94.9%	24,197.1	95.5	93.5
Beam (50%)	84.5%	21,539.9	80	79.7
Total	100%	25,489.8		

#### Tilt Angle- 45 Degree LLF-0.9

Mounting Height m (ft)	Maximum Point (fc)	Forward Throw Distance			
		0.5fc/5lx m (ft)	1fc/11lx m (ft)	2fc/22lx m (ft)	5fc/54lx m (ft)
9 (30)	6.94	28 (93)	21 (69)	16 (54)	10 (33)
12 (40)	3.85	30 (100)	23 (76)	17 (56)	9 (28)
15 (50)	2.46	31 (103)	23 (75)	15 (50)	—
18 (60)	1.71	33 (108)	24 (78)	15 (48)	—

Mounting Height m (ft)	Side-to-Side Distance			
	0.5fc/5lx m (ft)	1fc/11lx m (ft)	2fc/22lx m (ft)	5fc/54lx m (ft)
9 (30)	27 (90)	22 (72)	18 (60)	13 (42)
12 (40)	30 (100)	24 (80)	20 (64)	7 (24)
15 (50)	37 (120)	27 (90)	18 (60)	—
18 (60)	37 (120)	27 (90)	15 (48)	—

LED Luminaires | Floodlight | Hazardous Location | NEC / CEC / ATEX / IECEX



# Areamaster™ Generation 2 and High Lumen LED Series Luminaires

## Floodlight

### Hazardous Locations

NEC/CEC: Class I, Division 2, Groups A, B, C, D | Class II, Division 1, Groups E, F, G | Class II, Division 2, Groups F, G | Class III | Zone 20, 21 and 22 | Class I, Zone 2 AEx/Ex ec IIC Gc | Zone 21, AEx/Ex tb IIC Db | Type 3R, 4 and 4X | IP66/67 | Simultaneous Exposure | Marine Outside Type (Salt Water) for USA Only | Wet Locations  
 ATEX/IECEX: Zone 2, 21, 22 | II 2D 3G 3D | IK08 | IP66  
 Markings: CE | UKCA  
 Notable: American Bureau of Shipping (ABS) Certified | 10G Vibration

### Photometric Data — DATA SHOWN IS ABSOLUTE

NEMA 5x5, Clear Glass, 5000K CCT

REPORT NUMBER: AMLHL3CG5BU

Luminaire Lumens 38,350

#### POLAR CANDELA DISTRIBUTION

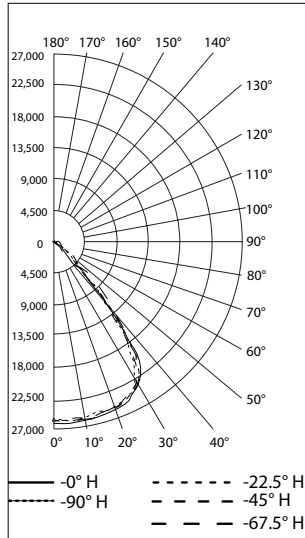

#### ISOLUX PLOT AT 45°

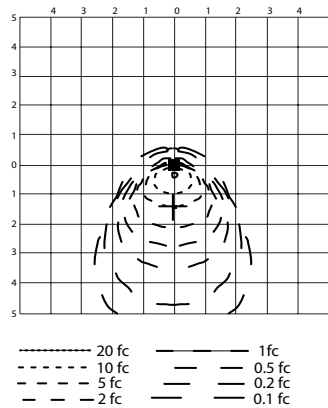

#### FLOOD SUMMARY

	Efficiency	Lumens	Horizontal Spread	Vertical Spread
Field (10%)	95.3%	36,528.8	89.8	92.9
Beam (50%)	84.4%	32,367.7	73.5	79.7
Total	100%	38,348.7		

#### Tilt Angle- 45 Degree LLF-0.9

Mounting Height m (ft)	Maximum Point (fc)	Forward Throw Distance			
		0.5fc/5lx m (ft)	1fc/11lx m (ft)	2fc/22lx m (ft)	5fc/54lx m (ft)
9 (30)	4.96	32 (105)	26 (84)	19 (63)	13 (42)
12 (40)	2.78	35 (116)	27 (88)	21 (68)	12 (40)
15 (50)	1.78	34 (110)	26 (85)	18 (60)	8 (25)
18 (60)	1.23	38 (126)	29 (96)	20 (66)	5 (18)

Mounting Height m (ft)	Side-to-Side Distance			
	0.5fc/5lx m (ft)	1fc/11lx m (ft)	2fc/22lx m (ft)	5fc/54lx m (ft)
9 (30)	33 (108)	27 (90)	22 (72)	16 (54)
12 (40)	37 (120)	30 (100)	24 (80)	15 (48)
15 (50)	40 (130)	30 (100)	24 (80)	9 (30)
18 (60)	44 (144)	37 (120)	26 (84)	4 (12)

NEMA 5x5, Clear Glass, 3000K CCT

REPORT NUMBER: AMLHL3WG5BU

Luminaire Lumens 32,835

#### POLAR CANDELA DISTRIBUTION

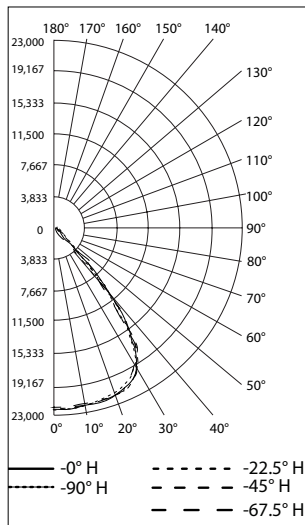

#### ISOLUX PLOT AT 45°

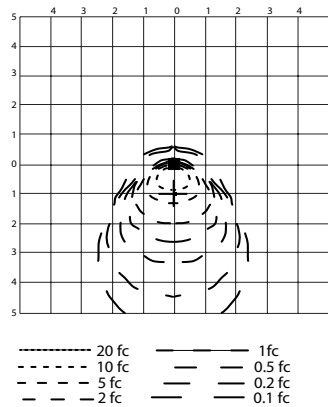

#### FLOOD SUMMARY

	Efficiency	Lumens	Horizontal Spread	Vertical Spread
Field (10%)	95%	31,186.0	96.1	93.5
Beam (50%)	84%	27,593.2	80.4	79.8
Total	100%	32,832.0		

#### Tilt Angle- 45 Degree LLF-0.9

Mounting Height m (ft)	Maximum Point (fc)	Forward Throw Distance			
		0.5fc/5lx m (ft)	1fc/11lx m (ft)	2fc/22lx m (ft)	5fc/54lx m (ft)
9 (30)	7.95	30 (99)	25 (81)	18 (60)	12 (39)
12 (40)	4.40	34 (112)	26 (84)	18 (60)	11 (36)
15 (50)	2.82	34 (110)	27 (90)	18 (60)	8 (25)
18 (60)	1.96	37 (120)	27 (90)	18 (60)	—

Mounting Height m (ft)	Side-to-Side Distance			
	0.5fc/5lx m (ft)	1fc/11lx m (ft)	2fc/22lx m (ft)	5fc/54lx m (ft)
9 (30)	33 (108)	26 (84)	20 (66)	16 (54)
12 (40)	37 (120)	29 (96)	24 (80)	12 (48)
15 (50)	40 (130)	30 (100)	24 (80)	9 (30)
18 (60)	40 (132)	35 (114)	22 (72)	—

# Areaster™ Generation 2 and High Lumen LED Series Luminaires

## Floodlight

### Hazardous Locations

NEC/CEC: Class I, Division 2, Groups A, B, C, D | Class II, Division 1, Groups E, F, G | Class II, Division 2, Groups F, G | Class III | Zone 20, 21 and 22 | Class I, Zone 2 AEx/Ex ec IIC Gc | Zone 21, AEx/Ex tb IIC Db | Type 3R, 4 and 4X | IP66/67 | Simultaneous Exposure | Marine Outside Type (Salt Water) for USA Only | Wet Locations  
 ATEX/IECEx: Zone 2, 21, 22 | II 2D 3G 3D | IK08 | IP66  
 Markings: CE | UKCA  
 Notable: American Bureau of Shipping (ABS) Certified | 10G Vibration

### Photometric Data — DATA SHOWN IS ABSOLUTE

NEMA 7x6 Clear Glass, 5000K CCT

REPORT NUMBER: AMLHL1CG7BU

Luminaire Lumens 22,661

#### POLAR CANDELA DISTRIBUTION

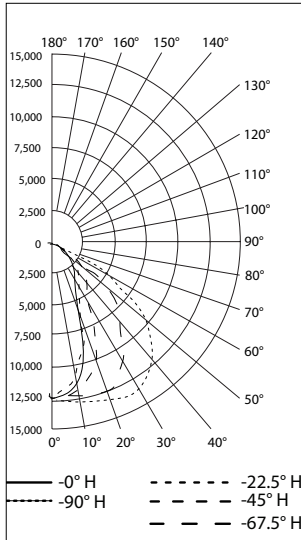

#### ISOLUX PLOT AT 45°

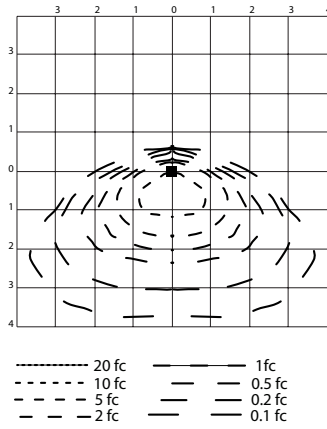

#### FLOOD SUMMARY

	Efficiency	Lumens	Horizontal Spread	Vertical Spread
Field (10%)	95.8%	21,708.2	134.1	111.1
Beam (50%)	61.4%	13,911.6	118.5	44.9
Total	100%	22,657.0		

#### Tilt Angle- 45 Degree LLF-0.9

Mounting Height m (ft)	Maximum Point (fc)	Forward Throw Distance			
		0.5fc/5lx m (ft)	1fc/11lx m (ft)	2fc/22lx m (ft)	5fc/54lx m (ft)
9 (30)	3.64	19 (63)	17 (57)	14 (54)	9 (29)
12 (40)	2.08	23 (76)	20 (64)	15 (48)	—
15 (50)	1.33	26 (85)	20 (65)	12 (40)	—
18 (60)	0.93	27 (90)	20 (66)	—	—

Mounting Height m (ft)	Side-to-Side Distance			
	0.5fc/5lx m (ft)	1fc/11lx m (ft)	2fc/22lx m (ft)	5fc/54lx m (ft)
9 (30)	38 (126)	33 (108)	23 (75)	13 (42)
12 (40)	44 (144)	32 (104)	22 (72)	—
15 (50)	46 (150)	30 (100)	15 (50)	—
18 (60)	46 (150)	29 (96)	—	—

NEMA 7x6 Clear Glass, 3000K CCT

REPORT NUMBER: AMLHL1WG7BU

Luminaire Lumens 19,753

#### POLAR CANDELA DISTRIBUTION

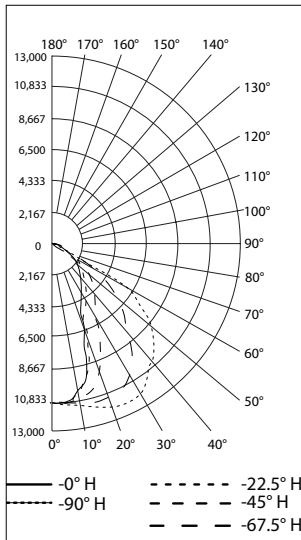

#### ISOLUX PLOT AT 45°

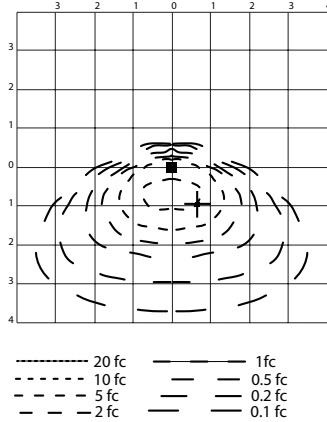

#### FLOOD SUMMARY

	Efficiency	Lumens	Horizontal Spread	Vertical Spread
Field (10%)	95.8%	18,919.3	134.7	111.5
Beam (50%)	61.1%	12,060.3	117.9	45.1
Total	100%	19,750.3		

#### Tilt Angle- 45 Degree LLF-0.9

Mounting Height m (ft)	Maximum Point (fc)	Forward Throw Distance			
		0.5fc/5lx m (ft)	1fc/11lx m (ft)	2fc/22lx m (ft)	5fc/54lx m (ft)
9 (30)	3.26	19 (63)	16 (54)	14 (45)	8 (27)
12 (40)	1.78	22 (72)	19 (62)	13 (42)	—
15 (50)	1.16	24 (80)	19 (62)	11 (35)	—
18 (60)	0.81	27 (90)	18 (60)	—	—

Mounting Height m (ft)	Side-to-Side Distance			
	0.5fc/5lx m (ft)	1fc/11lx m (ft)	2fc/22lx m (ft)	5fc/54lx m (ft)
9 (30)	37 (120)	27 (90)	21 (70)	8 (25)
12 (40)	40 (130)	30 (100)	18 (60)	—
15 (50)	43 (140)	27 (90)	6 (20)	—
18 (60)	43 (140)	24 (80)	—	—

LED Luminaires | Floodlight | Hazardous Location | NEC / CEC / ATEX / IECEx

# Areaster™ Generation 2 and High Lumen LED Series Luminaires

## Floodlight

### Hazardous Locations

NEC/CEC: Class I, Division 2, Groups A, B, C, D | Class II, Division 1, Groups E, F, G | Class II, Division 2, Groups F, G | Class III | Zone 20, 21 and 22 | Class I, Zone 2 AEx/Ex ec IIC Gc | Zone 21, AEx/Ex tb IIC Db | Type 3R, 4 and 4X | IP66/67 | Simultaneous Exposure | Marine Outside Type (Salt Water) for USA Only | Wet Locations  
 ATEX/IECEX: Zone 2, 21, 22 | II 2D 3G 3D | IK08 | IP66  
 Markings: CE | UKCA  
 Notable: American Bureau of Shipping (ABS) Certified | 10G Vibration

### Photometric Data — DATA SHOWN IS ABSOLUTE

NEMA 7x6 Clear Glass, 5000K CCT

REPORT NUMBER: AMLHL2CG7BU

Luminaire Lumens 28,063

#### POLAR CANDELA DISTRIBUTION

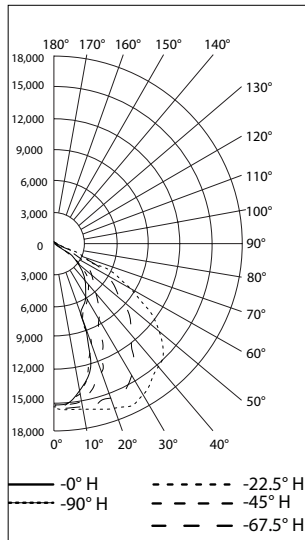

#### ISOLUX PLOT AT 45°

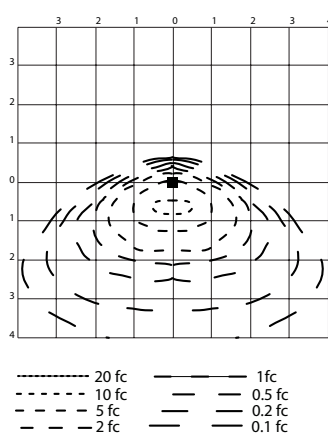

#### FLOOD SUMMARY

	Efficiency	Lumens	Horizontal Spread	Vertical Spread
Field (10%)	95.8%	26,888.8	134.1	111.1
Beam (50%)	61.5%	17,260.6	118.6	45
Total	100%	28,058.5		

#### Tilt Angle- 45 Degree LLF-0.9

Mounting Height m (ft)	Maximum Point (fc)	Forward Throw Distance			
		0.5fc/5lx m (ft)	1fc/11lx m (ft)	2fc/22lx m (ft)	5fc/54lx m (ft)
9 (30)	4.49	21 (68)	18 (60)	15 (48)	10 (32)
12 (40)	2.57	24 (80)	22 (72)	16 (52)	—
15 (50)	1.64	27 (90)	23 (75)	15 (50)	—
18 (60)	1.14	29 (96)	23 (75)	13 (42)	—

Mounting Height m (ft)	Side-to-Side Distance			
	0.5fc/5lx m (ft)	1fc/11lx m (ft)	2fc/22lx m (ft)	5fc/54lx m (ft)
9 (30)	41 (135)	35 (114)	24 (78)	15 (48)
12 (40)	46 (152)	37 (120)	24 (80)	—
15 (50)	49 (160)	37 (120)	23 (75)	—
18 (60)	48 (156)	33 (108)	9 (30)	—

NEMA 7x6 Clear Glass, 3000K CCT

REPORT NUMBER: AMLHL2WG7BU

Luminaire Lumens 23,532

#### POLAR CANDELA DISTRIBUTION

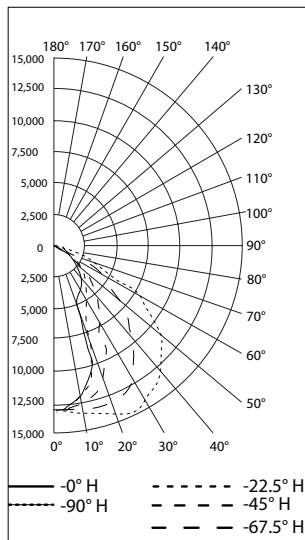

#### ISOLUX PLOT AT 45°

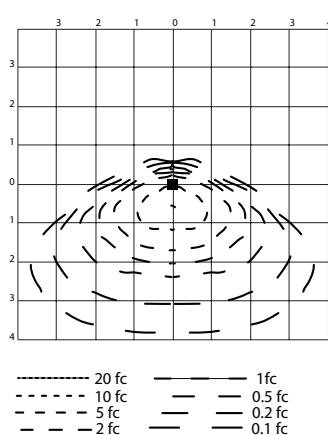

#### FLOOD SUMMARY

	Efficiency	Lumens	Horizontal Spread	Vertical Spread
Field (10%)	95.7%	22,530.7	134.6	111
Beam (50%)	60.9%	14,337.3	117.9	44.7
Total	100%	23,528.4		

#### Tilt Angle- 45 Degree LLF-0.9

Mounting Height m (ft)	Maximum Point (fc)	Forward Throw Distance			
		0.5fc/5lx m (ft)	1fc/11lx m (ft)	2fc/22lx m (ft)	5fc/54lx m (ft)
9 (30)	3.80	20 (66)	17 (57)	14 (45)	10 (32)
12 (40)	2.17	23 (76)	18 (60)	15 (48)	—
15 (50)	1.39	26 (85)	21 (70)	14 (45)	—
18 (60)	0.97	27 (90)	20 (66)	—	—

Mounting Height m (ft)	Side-to-Side Distance			
	0.5fc/5lx m (ft)	1fc/11lx m (ft)	2fc/22lx m (ft)	5fc/54lx m (ft)
9 (30)	38 (126)	33 (108)	22 (72)	13 (42)
12 (40)	44 (144)	34 (112)	22 (72)	—
15 (50)	46 (150)	30 (100)	18 (60)	—
18 (60)	48 (156)	29 (96)	—	—

LED Luminaires | Floodlight | Hazardous Location | NEC / CEC / ATEX / IECEX

# Areaster™ Generation 2 and High Lumen LED Series Luminaires

## Floodlight

### Hazardous Locations

NEC/CEC: Class I, Division 2, Groups A, B, C, D | Class II, Division 1, Groups E, F, G | Class II, Division 2, Groups F, G | Class III | Zone 20, 21 and 22 | Class I, Zone 2 AEx/Ex ec IIC Gc | Zone 21, AEx/Ex tb IIC Db | Type 3R, 4 and 4X | IP66/67 | Simultaneous Exposure | Marine Outside Type (Salt Water) for USA Only | Wet Locations  
 ATEX/IECEx: Zone 2, 21, 22 | II 2D 3G 3D | IK08 | IP66  
 Markings: CE | UKCA  
 Notable: American Bureau of Shipping (ABS) Certified | 10G Vibration

### Photometric Data — DATA SHOWN IS ABSOLUTE

NEMA 7x6 Clear Glass, 5000K CCT

REPORT NUMBER: AMLHL3CG7BU

Luminaire Lumens 35,430

#### POLAR CANDELA DISTRIBUTION

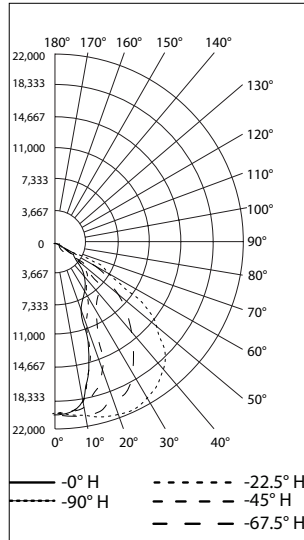

#### ISOLUX PLOT AT 45°

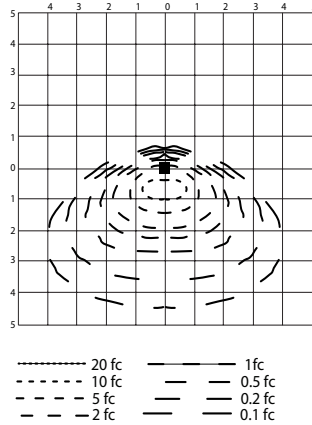

#### FLOOD SUMMARY

	Efficiency	Lumens	Horizontal Spread	Vertical Spread
Field (10%)	95.7%	33,908.8	139	111.1
Beam (50%)	60.9%	21,578.5	115.4	45.6
Total	100%	35,424.1		

#### Tilt Angle- 45 Degree LLF-0.9

Mounting Height m (ft)	Maximum Point (fc)	Forward Throw Distance			
		0.5fc/5lx m (ft)	1fc/11lx m (ft)	2fc/22lx m (ft)	5fc/54lx m (ft)
9 (30)	5.69	22 (72)	19 (62)	16 (54)	11 (36)
12 (40)	3.20	26 (84)	22 (72)	17 (56)	10 (32)
15 (50)	2.05	29 (95)	24 (80)	18 (60)	—
18 (60)	1.42	32 (105)	24 (78)	16 (54)	—

Mounting Height m (ft)	Side-to-Side Distance			
	0.5fc/5lx m (ft)	1fc/11lx m (ft)	2fc/22lx m (ft)	5fc/54lx m (ft)
9 (30)	42 (138)	37 (120)	27 (90)	18 (60)
12 (40)	49 (160)	37 (120)	27 (88)	12 (40)
15 (50)	55 (180)	40 (130)	27 (90)	—
18 (60)	55 (180)	40 (132)	22 (72)	—

NEMA 7x6 Clear Glass, 3000K CCT

REPORT NUMBER: AMLHL3WG7BU

Luminaire Lumens 30,346

#### POLAR CANDELA DISTRIBUTION

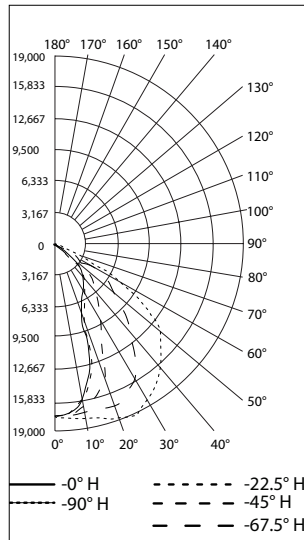

#### ISOLUX PLOT AT 45°

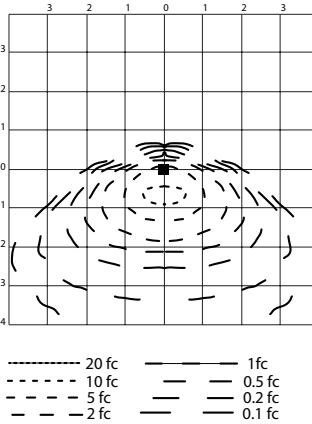

#### FLOOD SUMMARY

	Efficiency	Lumens	Horizontal Spread	Vertical Spread
Field (10%)	95%	31,186.0	96.1	93.5
Beam (50%)	84%	27,593.2	80.4	79.8
Total	100%	32,832.0		

#### Tilt Angle- 45 Degree LLF-0.9

Mounting Height m (ft)	Maximum Point (fc)	Forward Throw Distance			
		0.5fc/5lx m (ft)	1fc/11lx m (ft)	2fc/22lx m (ft)	5fc/54lx m (ft)
9 (30)	4.99	21 (69)	18 (60)	16 (54)	10 (33)
12 (40)	2.81	25 (82)	22 (72)	16 (52)	9 (28)
15 (50)	1.79	27 (90)	23 (75)	17 (55)	—
18 (60)	1.25	29 (96)	23 (75)	15 (48)	—

Mounting Height m (ft)	Side-to-Side Distance			
	0.5fc/5lx m (ft)	1fc/11lx m (ft)	2fc/22lx m (ft)	5fc/54lx m (ft)
9 (30)	41 (135)	35 (114)	26 (84)	16 (54)
12 (40)	49 (160)	37 (120)	24 (80)	2 (8)
15 (50)	49 (160)	37 (120)	23 (75)	—
18 (60)	51 (168)	37 (120)	18 (60)	—

LED Luminaires | Floodlight | Hazardous Location | NEC / CEC / ATEX / IECEx

# Areamaster™ Generation 2 and High Lumen LED Series Luminaires

## Floodlight

### Hazardous Locations

NEC/CEC: Class I, Division 2, Groups A, B, C, D | Class II, Division 1, Groups E, F, G | Class II, Division 2, Groups F, G | Class III | Zone 20, 21 and 22 | Class I, Zone 2 AEx/Ex ec IIC Gc | Zone 21, AEx/Ex tb IIC Db | Type 3R, 4 and 4X | IP66/67 | Simultaneous Exposure | Marine Outside Type (Salt Water) for USA Only | Wet Locations  
 ATEX/IECEX: Zone 2, 21, 22 | II 2D 3G 3D | IK08 | IP66  
 Markings: CE | UKCA  
 Notable: American Bureau of Shipping (ABS) Certified | 10G Vibration

### Photometric Data — DATA SHOWN IS ABSOLUTE

NEMA 7x7 Diffused Glass, 5000K CCT

REPORT NUMBER: AMLHL1CF6BU

Luminaire Lumens 20,578

#### POLAR CANDELA DISTRIBUTION

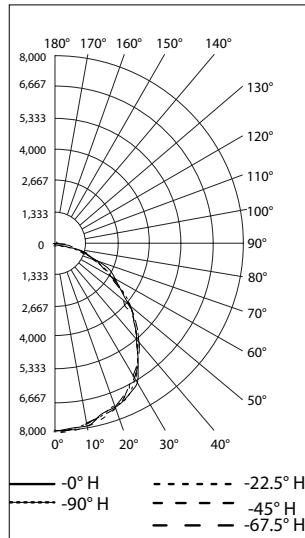

#### ISOLUX PLOT AT 45°

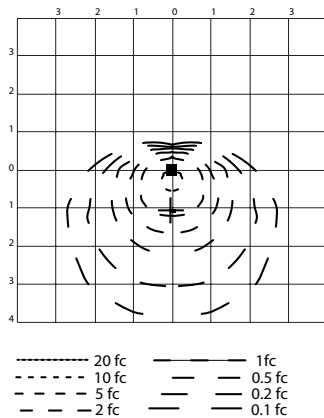

#### FLOOD SUMMARY

	Efficiency	Lumens	Horizontal Spread	Vertical Spread
Field (10%)	98%	20,176.5	155.7	154.5
Beam (50%)	70.2%	14,453.8	104.6	103.6
Total	100%	20,571.8		

Tilt Angle- 45 Degree LLF-0.9

Mounting Height m (ft)	Maximum Point (fc)	Forward Throw Distance			
		0.5fc/5lx m (ft)	1fc/11lx m (ft)	2fc/22lx m (ft)	5fc/54lx m (ft)
9 (30)	2.47	20 (66)	16 (54)	11 (36)	4 (12)
12 (40)	1.40	22 (72)	16 (52)	10 (32)	—
15 (50)	0.89	21 (70)	15 (50)	6 (20)	—
18 (60)	0.62	22 (72)	13 (42)	—	—

Mounting Height m (ft)	Side-to-Side Distance			
	0.5fc/5lx m (ft)	1fc/11lx m (ft)	2fc/22lx m (ft)	5fc/54lx m (ft)
9 (30)	31 (102)	22 (72)	16 (54)	4 (12)
12 (40)	32 (104)	22 (72)	12 (40)	—
15 (50)	30 (100)	21 (70)	5 (15)	—
18 (60)	33 (108)	15 (48)	—	—

### NEMA 7x7 Clear Glass, 5000K CCT

REPORT NUMBER: AMLHL1CG6BU

Luminaire Lumens 23,457

#### POLAR CANDELA DISTRIBUTION

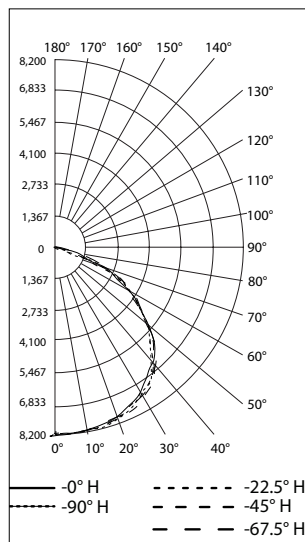

#### ISOLUX PLOT AT 45°

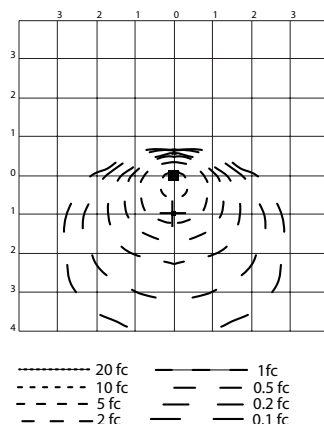

#### FLOOD SUMMARY

	Efficiency	Lumens	Horizontal Spread	Vertical Spread
Field (10%)	98.4%	23,090.9	151.1	151.2
Beam (50%)	80.3%	18,837.0	115.2	116.4
Total	100%	23,448.8		

Tilt Angle- 45 Degree LLF-0.9

Mounting Height m (ft)	Maximum Point (fc)	Forward Throw Distance			
		0.5fc/5lx m (ft)	1fc/11lx m (ft)	2fc/22lx m (ft)	5fc/54lx m (ft)
9 (30)	2.84	20 (66)	16 (54)	11 (36)	5 (15)
12 (40)	1.60	22 (72)	17 (56)	10 (32)	—
15 (50)	1.03	23 (75)	15 (50)	6 (20)	—
18 (60)	0.71	23 (75)	14 (45)	—	—

Mounting Height m (ft)	Side-to-Side Distance			
	0.5fc/5lx m (ft)	1fc/11lx m (ft)	2fc/22lx m (ft)	5fc/54lx m (ft)
9 (30)	33 (108)	24 (78)	18 (60)	7 (24)
12 (40)	34 (112)	24 (80)	15 (48)	—
15 (50)	37 (120)	24 (80)	12 (40)	—
18 (60)	35 (114)	18 (60)	—	—

LED Luminaires | Floodlight | Hazardous Location | NEC / CEC / ATEX / IECEX

# Areaster™ Generation 2 and High Lumen LED Series Luminaires

## Floodlight

### Hazardous Locations

NEC/CEC: Class I, Division 2, Groups A, B, C, D | Class II, Division 1, Groups E, F, G | Class II, Division 2, Groups F, G | Class III | Zone 20, 21 and 22 | Class I, Zone 2 AEx/Ex ec IIC Gc | Zone 21, AEx/Ex tb IIC Db | Type 3R, 4 and 4X | IP66/67 | Simultaneous Exposure | Marine Outside Type (Salt Water) for USA Only | Wet Locations  
 ATEX/IECEx: Zone 2, 21, 22 | II 2D 3G 3D | IK08 | IP66  
 Markings: CE | UKCA  
 Notable: American Bureau of Shipping (ABS) Certified | 10G Vibration

### Photometric Data — DATA SHOWN IS ABSOLUTE

#### NEMA 7x7 Diffused Glass, 5000K CCT

REPORT NUMBER: AMLHL2CF6BU

Luminaire Lumens 25,616

#### POLAR CANDELA DISTRIBUTION

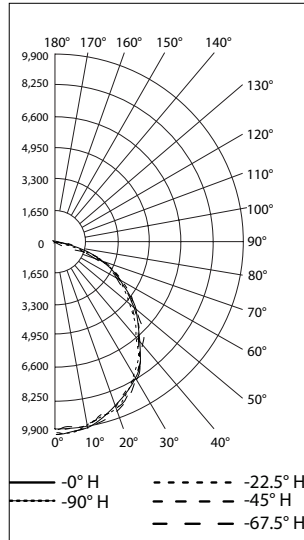

#### ISOLUX PLOT AT 45°

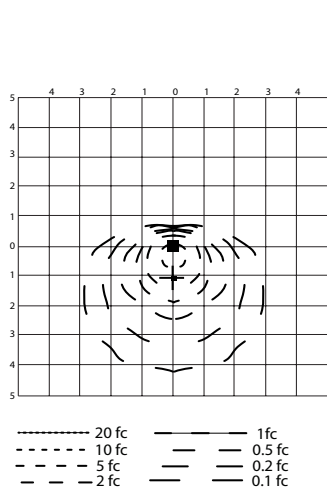

#### FLOOD SUMMARY

	Efficiency	Lumens	Horizontal Spread	Vertical Spread
Field (10%)	98.1%	25,135.5	155.9	154.5
Beam (50%)	69.9%	17,911.8	104.6	103.7
Total	100%	25,609.0		

#### Tilt Angle- 45 Degree LLF-0.9

Mounting Height m (ft)	Maximum Point (fc)	Forward Throw Distance			
		0.5fc/5lx m (ft)	1fc/11lx m (ft)	2fc/22lx m (ft)	5fc/54lx m (ft)
9 (30)	3.07	22 (72)	17 (57)	12 (39)	6 (21)
12 (40)	1.70	24 (80)	17 (56)	12 (40)	—
15 (50)	1.09	24 (80)	18 (60)	9 (30)	—
18 (60)	0.76	24 (78)	16 (54)	—	—

Mounting Height m (ft)	Side-to-Side Distance			
	0.5fc/5lx m (ft)	1fc/11lx m (ft)	2fc/22lx m (ft)	5fc/54lx m (ft)
9 (30)	33 (108)	24 (78)	18 (60)	7 (24)
12 (40)	34 (112)	24 (80)	17 (56)	—
15 (50)	37 (120)	24 (80)	15 (50)	—
18 (60)	37 (120)	18 (60)	—	—

#### NEMA 7x7 Clear Glass, 5000K CCT

REPORT NUMBER: AMLHL2CG6BU

Luminaire Lumens 30,157

#### POLAR CANDELA DISTRIBUTION

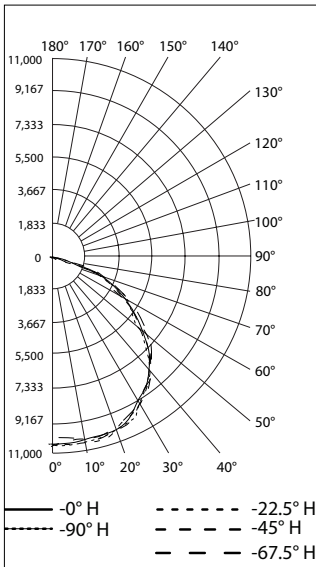

#### ISOLUX PLOT AT 45°

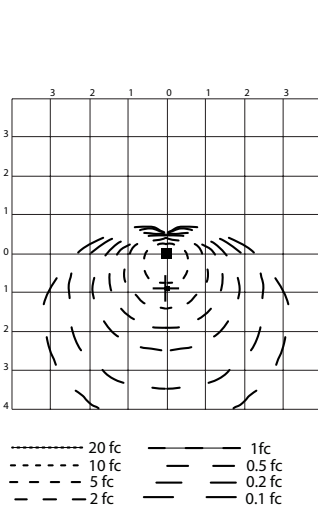

#### FLOOD SUMMARY

	Efficiency	Lumens	Horizontal Spread	Vertical Spread
Field (10%)	98.2%	29,616.7	151.4	145.9
Beam (50%)	81.2%	24,501.2	116.8	117.7
Total	100%	30,147.4		

#### Tilt Angle- 45 Degree LLF-0.9

Mounting Height m (ft)	Maximum Point (fc)	Forward Throw Distance			
		0.5fc/5lx m (ft)	1fc/11lx m (ft)	2fc/22lx m (ft)	5fc/54lx m (ft)
9 (30)	4.17	23 (75)	17 (57)	13 (42)	7 (24)
12 (40)	2.35	24 (80)	18 (60)	12 (40)	—
15 (50)	1.49	24 (80)	18 (60)	9 (30)	—
18 (60)	1.04	26 (84)	16 (54)	7 (24)	—

Mounting Height m (ft)	Side-to-Side Distance			
	0.5fc/5lx m (ft)	1fc/11lx m (ft)	2fc/22lx m (ft)	5fc/54lx m (ft)
9 (30)	35 (114)	26 (84)	19 (63)	9 (30)
12 (40)	37 (120)	27 (88)	20 (64)	—
15 (50)	37 (120)	24 (80)	15 (50)	—
18 (60)	37 (120)	22 (72)	9 (30)	—

LED Luminaires | Floodlight | Hazardous Location | NEC / CEC / ATEX / IECEx



# Areamaster™ Generation 2 and High Lumen LED Series Luminaires

## Floodlight

### Hazardous Locations

NEC/CEC: Class I, Division 2, Groups A, B, C, D | Class II, Division 1, Groups E, F, G | Class II, Division 2, Groups F, G | Class III | Zone 20, 21 and 22 | Class I, Zone 2 AEx/Ex ec IIC Gc | Zone 21, AEx/Ex tb IIC Db | Type 3R, 4 and 4X | IP66/67 | Simultaneous Exposure | Marine Outside Type (Salt Water) for USA Only | Wet Locations  
 ATEX/IECEX: Zone 2, 21, 22 | II 2D 3G 3D | IK08 | IP66  
 Markings: CE | UKCA  
 Notable: American Bureau of Shipping (ABS) Certified | 10G Vibration

### Photometric Data — DATA SHOWN IS ABSOLUTE

NEMA 7x7 Diffused Glass, 5000K CCT

REPORT NUMBER: AMLHL3CF6BU

Luminaire Lumens 31,600

#### POLAR CANDELA DISTRIBUTION

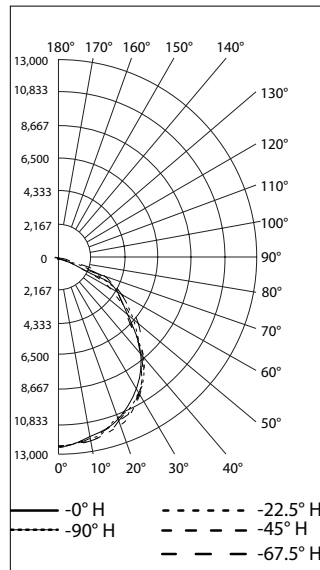

#### ISOLUX PLOT AT 45°

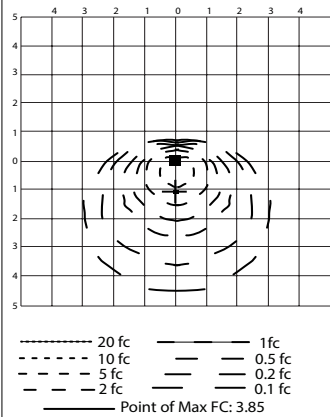

#### FLOOD SUMMARY

	Efficiency	Lumens	Horizontal Spread	Vertical Spread
Field (10%)	97.9%	30,947.7	156	154.1
Beam (50%)	69.5%	21,961.6	104	102.9
Total	100%	31,591.2		

#### Tilt Angle- 45 Degree LLF-0.9

Mounting Height m (ft)	Maximum Point (fc)	Forward Throw Distance			
		0.5fc/5lx m (ft)	1fc/11lx m (ft)	2fc/22lx m (ft)	5fc/54lx m (ft)
9 (30)	3.82	24 (78)	18 (60)	13 (42)	8 (27)
12 (40)	2.15	26 (84)	18 (60)	13 (44)	—
15 (50)	1.38	27 (88)	20 (65)	12 (40)	—
18 (60)	0.96	27 (90)	20 (66)	7 (24)	—

Mounting Height m (ft)	Side-to-Side Distance			
	0.5fc/5lx m (ft)	1fc/11lx m (ft)	2fc/22lx m (ft)	5fc/54lx m (ft)
9 (30)	35 (114)	26 (84)	18 (60)	9 (30)
12 (40)	37 (120)	27 (88)	20 (56)	—
15 (50)	38 (125)	27 (90)	15 (50)	—
18 (60)	40 (132)	22 (72)	—	—

### NEMA 7x7 Clear Glass, 5000K CCT

REPORT NUMBER: AMLHL3CG6BU

Luminaire Lumens 37,039

#### POLAR CANDELA DISTRIBUTION

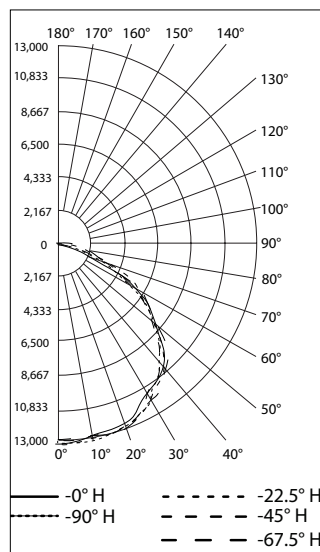

#### ISOLUX PLOT AT 45°

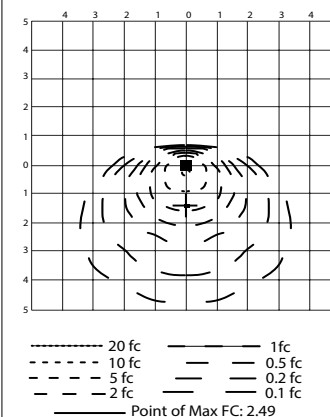

#### FLOOD SUMMARY

	Efficiency	Lumens	Horizontal Spread	Vertical Spread
Field (10%)	98.3%	36,391.3	152.3	150.9
Beam (50%)	79.5%	29,452.1	114.2	115.8
Total	100%	37,028.2		

#### Tilt Angle- 45 Degree LLF-0.9

Mounting Height m (ft)	Maximum Point (fc)	Forward Throw Distance			
		0.5fc/5lx m (ft)	1fc/11lx m (ft)	2fc/22lx m (ft)	5fc/54lx m (ft)
9 (30)	2.44	26 (84)	19 (63)	14 (45)	8 (27)
12 (40)	1.37	27 (88)	21 (68)	15 (48)	5 (16)
15 (50)	0.88	27 (90)	20 (65)	12 (40)	—
18 (60)	0.60	27 (90)	20 (66)	9 (30)	—

Mounting Height m (ft)	Side-to-Side Distance			
	0.5fc/5lx m (ft)	1fc/11lx m (ft)	2fc/22lx m (ft)	5fc/54lx m (ft)
9 (30)	37 (120)	27 (90)	22 (72)	13 (42)
12 (40)	41 (136)	30 (100)	22 (72)	6 (20)
15 (50)	40 (130)	30 (100)	18 (60)	—
18 (60)	44 (144)	29 (96)	15 (48)	—